

Miller

FINE BATHROOM INTERIORS



BATHROOM ACCESSORIES AND FURNITURE 2025

Your way. The Miller Way.

Given how much time your family spends in the bathroom you deserve something extra. As a timeless and beautiful design, just like your family, it becomes more beautiful with age.

Added care is given to the selected materials and finish, along with all the little details that make the products so beautiful. And not least, the choice that will give you the bathroom you really desire.

We believe that it is important your whole family enjoys dealing with us, as we ourselves are a family business that for five generations has delivered quality, authenticity and tradition.

We also believe that your family deserves a good quality of life, even in the bathroom. We call it the Miller Way.

Our products



Bathroom Accessories **page 4**



Bathroom Furniture **page 62**

Care in every detail

We know the surface is important in bathrooms. That's the first thing your eyes see when you enter the room. A beautiful wall cabinet, the clean lines of a vanity unit, an elegantly shaped porcelain sink creates that special first impression. But it's once you get to know your bathroom a little closer you will appreciate our attention to detail. Beneath the surface there are all those little details that become more important over the years.

We select wood with beautiful veining and finish with hard wearing, protective lacquer. We are careful to design drawers and doors which always open and close smoothly. We have thought about the extra storage that will be practical and functional. Everything we design is for a long lasting friendship. This is when the small details combine with the beautiful surfaces to give you a special bathroom – the Miller Way.

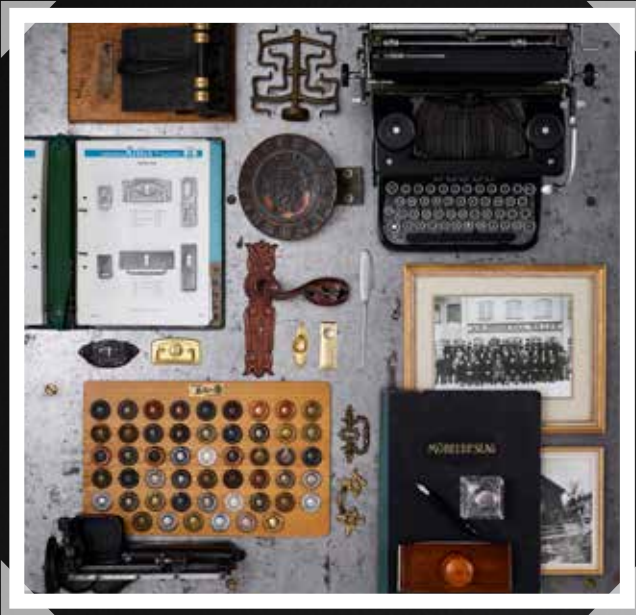

Our History

In 1903, two brothers, Justus and Fritz Miller started casting furniture fittings in little Printzeryd in Sweden. They were skilled craftsmen who took great care with the fittings they supplied to make sure that they were of the highest quality.

Today, over 100 years later, that same philosophy stands and with the business still under the Miller's ownership, and the family remains fully committed to the production of high quality, visually stunning products which stand the test of time.



Bathroom Accessories

The perfect way to finish your bathroom is with the addition of one of Miller from Sweden's beautiful accessory collections. Thoughtfully designed to complement our furniture, there are many stylish and innovative solutions to choose from.

- | | | | |
|----|----------------------|----|----------------------|
| 6 | Atlanta Chrome | 30 | Orlando |
| 8 | Atlanta Black | 32 | Oslo Chrome |
| 10 | Bond Chrome | 34 | Oslo Nickel |
| 12 | Bond Black | 36 | Richmond |
| 14 | Bond Brushed Brass | 38 | Stockholm |
| 16 | Boston | 42 | Signature Collection |
| 18 | Metro | 60 | Cube |
| 20 | Miami Chrome | 61 | Lily |
| 22 | Miami Gun Metal | | |
| 24 | Miami Black | | |
| 26 | Miami Brushed Nickel | | |
| 28 | Montana | | |



These accessories can also be fixed with our adhesive. All accessories are supplied with a wall screw pack. For "No drill" fixing purchase our fixing adhesive.





Atlanta Chrome **6**



Atlanta Black **8**



Bond Chrome **10**



Bond Black **12**



Bond Brushed Brass **14**



Boston **16**



Metro **18**



Miami Chrome **20**



Miami Gun Metal **22**



Miami Black **24**



Miami Brushed Nickel **26**



Montana **28**



Orlando **30**



Oslo Chrome **32**

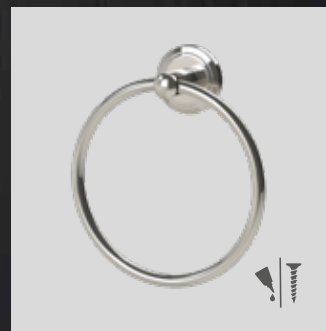

Oslo Polished Nickel **34**



Richmond **36**



Stockholm **38**



Signature Collection **42**



Cube **60**

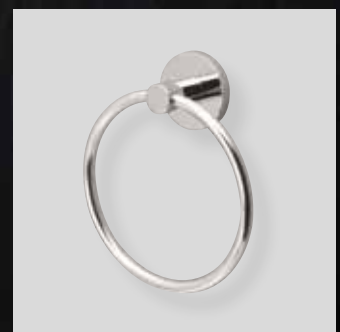

Lily **61**

ATLANTA

Atlanta's pure form and function provides a perfect balance of design and practicality. Benefiting from our full-fix system, this beautiful, chrome plated collection, provides everything you could wish for the finishing of your bathroom.

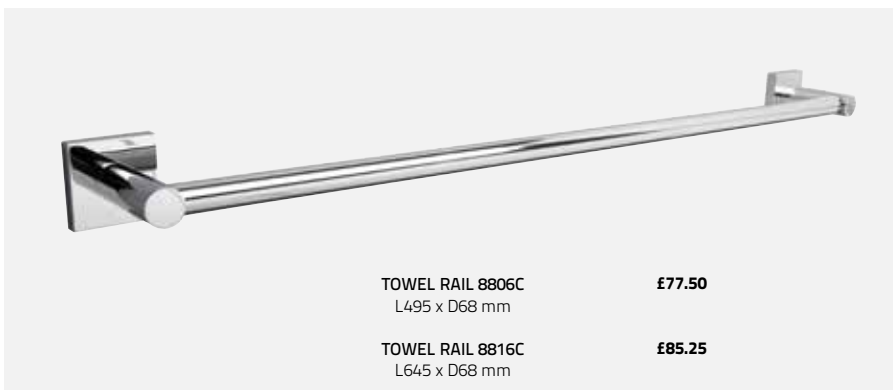

Screws are included. This collection can also be fixed with our Fixing Adhesive.

We recommend that towel rails, glass shelves, mirrors, toilet brush sets, grab bars and products that carry heavy weight are screw fixed.



10 year Guarantee

Read more about the Miller Way on millerbathrooms.co.uk



Full-fix 'anti twist' is a fixing system which prevents the accessory from turning when fitted.



Fixing Adhesive £16.50
Fixing Adhesive code no. 8798
Glue always sold separately.
Read more on millerbathrooms.co.uk

LEARN MORE

Find coordinating products in our Signature Collection on pages 42-59.

For detailed measurements please see millerbathrooms.co.uk

Backplate 45 x 45 mm



£34.75

DOUBLE HOOK 8823C
D55 mm



£31

SINGLE HOOK 8822C
D53 x H52 x W45 mm



£48.75

SOAP DISH 8804C
Clear glass
W130 x D135 x H47 mm



£48.75

TOWEL RING 8805C
W160 x H180 x D53 mm



£124.25

MIRROR 8800C
Bevelled
W420 x H500 mm
Range mirror is guaranteed for 2 years.



£48.75

TUMBLER HOLDER 8803C
Clear glass
D124 X H116 X W67 mm



£41

DOUBLE ROBE HOOK 8812C
W45 x H143 x D80 mm



£119.50

SHELF 8802C
Guard rail in chrome, clear hardened glass
L500 x D120 mm

ATLANTA BLACK

Atlanta's pure form and function provides a perfect balance of design and practicality. Benefiting from our full-fix system, this beautiful, matt black collection, provides everything you could wish for the finishing of your bathroom.



Screws are included. This collection can also be fixed with our Fixing Adhesive.

We recommend that towel rails, glass shelves, mirrors, toilet brush sets, grab bars and products that carry heavy weight are screw fixed.



10 year Guarantee

Read more about the Miller Way on millerbathrooms.co.uk



'Full-fix 'anti twist' is a fixing system which prevents the accessory from turning when fitted.



Fixing Adhesive £16.50
Fixing Adhesive code no. 8798
Glue always sold separately.
Read more on millerbathrooms.co.uk

LEARN MORE

Find coordinating products in our Signature Collection on pages 42-59.

For detailed measurements please see millerbathrooms.co.uk

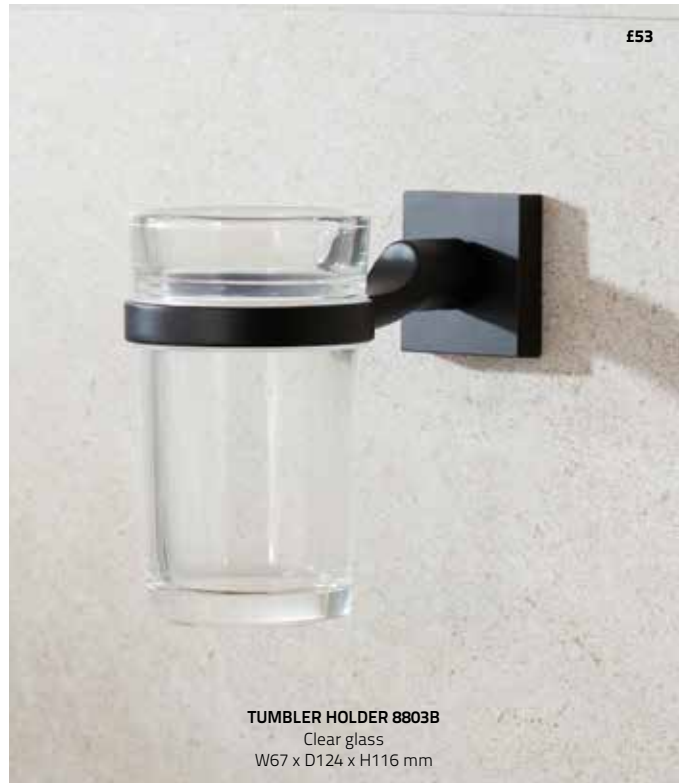

Find coordinating products in our Signature Collection on pages 42-59.



BOND

A modern day classic collection featuring pure, simple clean lines, finished in polished chrome with complementary glass component parts. Bond benefits from our full-fix system to prevent twisting, making it even more desirable and the perfect range for today's modern home.



£48.75

TOILET ROLL HOLDER 8710C
W150 x H105 mm



£63

TOILET ROLL HOLDER 8707C
with lid
W135 x H145 mm



£77.50

DOUBLE POST TOILET ROLL HOLDER 8737C
W205 x D70 mm

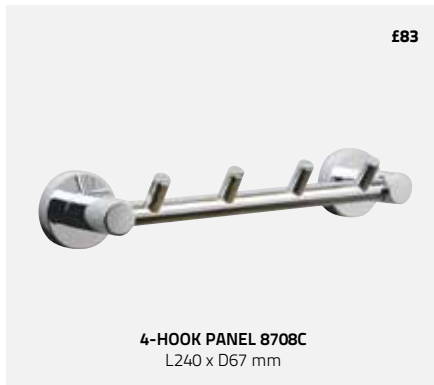

£83

4-HOOK PANEL 8708C
L240 x D67 mm



£59.75

SPARE ROLL HOLDER 8719C
H155 x D70 mm



TOWEL RAIL 8706C **£77.50**
L495 x D80 mm

TOWEL RAIL 8716C **£85.25**
L645 x D80 mm



£124.25

MIRROR 8700C
Round, bevelled
Ø450 mm
Range mirror is guaranteed for 2 years.



£125

TOWEL RAIL 8727C
Double
L645 x D155 mm



Screws are included. This collection can also be fixed with our Fixing Adhesive.

We recommend that towel rails, glass shelves, mirrors, toilet brush sets, grab bars and products that carry heavy weight are screw fixed.



10 year Guarantee

Read more about the Miller Way on millerbathrooms.co.uk



'Full-fix 'anti twist' is a fixing system which prevents the accessory from turning when fitted.



Fixing Adhesive £16.50
Fixing Adhesive code no. 8798
Glue always sold separately.
Read more on millerbathrooms.co.uk

LEARN MORE

Find coordinating products in our Signature Collection on pages 42-59.

For detailed measurements please see millerbathrooms.co.uk



BOND BLACK

A modern day classic collection featuring pure, simple clean lines, finished in matt black colour with complementary glass component parts. Bond benefits from our full-fix system to prevent twisting, making it even more desirable and the perfect range for today's modern home.



Screws are included. This collection can also be fixed with our Fixing Adhesive.

We recommend that towel rails, glass shelves, mirrors, toilet brush sets, grab bars and products that carry heavy weight are screw fixed.



10 year Guarantee

Read more about the Miller Way on millerbathrooms.co.uk



'Full-fix 'anti twist' is a fixing system which prevents the accessory from turning when fitted.



Fixing Adhesive £16.50
Fixing Adhesive code no. 8798
Glue always sold separately.
Read more on millerbathrooms.co.uk

LEARN MORE

Find coordinating products in our Signature Collection on pages 42-59.

For detailed measurements please see millerbathrooms.co.uk

Backplate diameter Ø45 mm

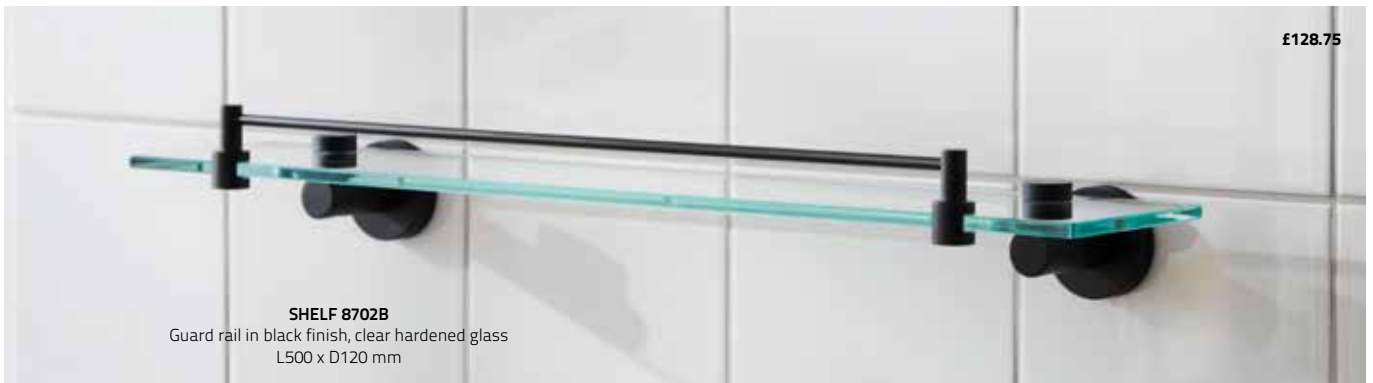

Find coordinating products in our Signature Collection on pages 42-59.



BOND BRUSHED BRASS

A modern day classic collection featuring pure, simple clean lines, finished in brushed laquered brass with complementary glass component parts. Bond benefits from our full-fix system to prevent twisting, making it even more desirable and the perfect range for today's modern home.



Screws are included. This collection can also be fixed with our Fixing Adhesive.

We recommend that towel rails, glass shelves, mirrors, toilet brush sets, grab bars and products that carry heavy weight are screw fixed.



10 year Guarantee

Read more about the Miller Way on millerbathrooms.co.uk



'Full-fix 'anti twist' is a fixing system which prevents the accessory from turning when fitted.



Fixing Adhesive £16.50
Fixing Adhesive code no. 8798
Glue always sold separately.
Read more on millerbathrooms.co.uk

LEARN MORE

Find coordinating products in our Signature Collection on pages 42-59.

For detailed measurements please see millerbathrooms.co.uk

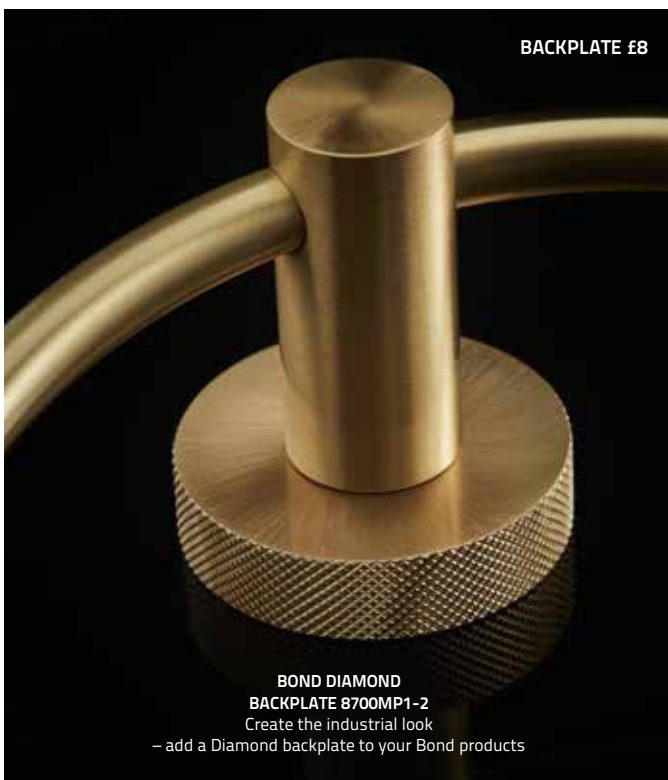

BOSTON

Architecturally inspired to produce a stunning image of sharp, clean angles and industrial style effects, the Boston collection benefits from full-fix fittings and is manufactured from solid brass. Its striking chrome lustre and beautiful ceramic components help to create a new contemporary classic.



£116.25

LOTION BOTTLE 8134C
White ceramic
W75 x H175 x D110 mm



£45.25

DOUBLE HOOK 8123C
W100 x H30 x D56 mm



£71.75

TUMBLER HOLDER 8103C
Tumbler in white ceramic
W80 x H115 x D105 mm



SWIVEL TOILET ROLL HOLDER 8107C £66.50
Swivel arm. Right or Left arm positioning.
W146 x H62 x D74 mm



£71.75

SOAP DISH 8104C
Dish in white ceramic
W125 x H40 x D130 mm



Screws are included. This collection can also be fixed with our Fixing Adhesive.

We recommend that towel rails, glass shelves, mirrors, toilet brush sets, grab bars and products that carry heavy weight are screw fixed.



Lifetime Guarantee

Read more about the Miller Way on millerbathrooms.co.uk



'Full-fix 'anti twist' is a fixing system which prevents the accessory from turning when fitted.



Fixing Adhesive £16.50
Fixing Adhesive code no. 8798
Glue always sold separately.
Read more on millerbathrooms.co.uk

LEARN MORE

Find coordinating products in our Signature Collection on pages 42-59.

For detailed measurements please see millerbathrooms.co.uk



Find coordinating products in our Signature Collection on pages 42-59.



METRO

Metro is an exceptional range of innovative brass accessories, finished in chrome and complemented by a satin chrome decorative ring on the back plate. Featuring frosted glass component parts, the stylish 'mixage' finish creates an outstanding collection of contemporary products.

£55.75



TOILET ROLL HOLDER 6310C-S
W170 x D55 mm

£55.75



TOWEL RING 6305C-S
Ø155 mm

£83



4-HOOK PANEL 6308C-S
W225 mm

£53.75



SOAP DISH 6304C-S
Frosted glass
Ø110 x D130 mm



This collection is screwfixed.
Screws are included



10 year Guarantee

Read more about
the Miller Way on
millerbathrooms.co.uk

LEARN MORE

Find coordinating products in our
Signature Collection on pages 42-59.

For detailed measurements
please see millerbathrooms.co.uk

Solid brass in chrome finish. With a decorative satin chrome ring.
Backplate 37 x 37 mm

£22



SINGLE HOOK 6309C-S
D35 mm

£145



DOUBLE TOWEL RAIL 6327C-S
L655 x D160 mm



TOWEL RAIL 6306C-S £90.25
L505 x D75 mm

TOWEL RAIL 6316C-S £96.75
L655 x D75 mm

£107.50



GLASS SHELF 6302C-S
L500 x D125 mm

MIAMI CHROME

Miami's strong form and contemporary shape is both elegant and stylish. Created from solid brass, finished by hand and chrome plated to a very high standard. It features our full-fix wall fitting system to ensure your accessories will enhance your bathroom for many years to come.



Screws are included. This collection can also be fixed with our Fixing Adhesive.

We recommend that towel rails, glass shelves, mirrors, toilet brush sets, grab bars and products that carry heavy weight are screw fixed.



Lifetime Guarantee

Read more about the Miller Way on millerbathrooms.co.uk



Full-fix 'anti twist' is a fixing system which prevents the accessory from turning when fitted.



Fixing Adhesive £16.50
Fixing Adhesive code no. 8798
Glue always sold separately.
Read more on millerbathrooms.co.uk

LEARN MORE

For detailed measurements please see millerbathrooms.co.uk

Miami is also available in Gun Metal, Matt Black and Brushed Nickel finish.

Find coordinating products in our Signature Collection on pages 42-59.

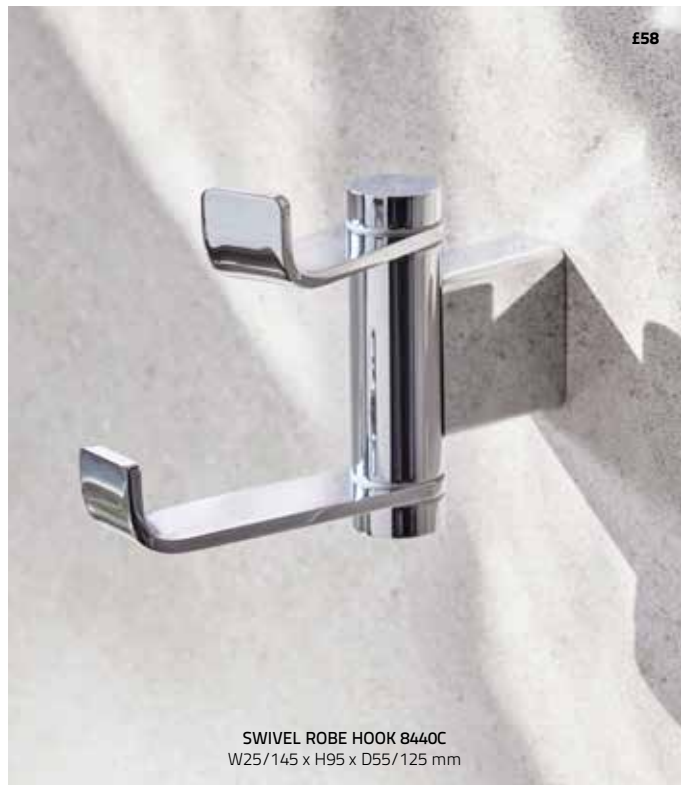

MIAMI GUN METAL



Screws are included. This collection can also be fixed with our Fixing Adhesive.

We recommend that towel rails, glass shelves, mirrors, toilet brush sets, grab bars and products that carry heavy weight are screw fixed.



Lifetime Guarantee

Read more about the Miller Way on millerbathrooms.co.uk



Full-fix 'anti twist' is a fixing system which prevents the accessory from turning when fitted.



Fixing Adhesive £16.50
Fixing Adhesive code no. 8798
Glue always sold separately.
Read more on millerbathrooms.co.uk

LEARN MORE

For detailed measurements please see millerbathrooms.co.uk

Miami is also available in Chrome, Matt Black and Brushed Nickel finish.

Find coordinating products in our Signature Collection on pages 42-59.



MIAMI BLACK



Screws are included. This collection can also be fixed with our Fixing Adhesive.

We recommend that towel rails, glass shelves, mirrors, toilet brush sets, grab bars and products that carry heavy weight are screw fixed.



Lifetime Guarantee

Read more about the Miller Way on millerbathrooms.co.uk



Full-fix 'anti twist' is a fixing system which prevents the accessory from turning when fitted.



Fixing Adhesive £16.50
Fixing Adhesive code no. 8798
Glue always sold separately.
Read more on millerbathrooms.co.uk

LEARN MORE

For detailed measurements please see millerbathrooms.co.uk

Miami is also available in Chrome, Gun Metal and Brushed Nickel finish.

Find coordinating products in our Signature Collection on pages 42-59.



MIAMI BRUSHED NICKEL



Screws are included. This collection can also be fixed with our Fixing Adhesive.

We recommend that towel rails, glass shelves, mirrors, toilet brush sets, grab bars and products that carry heavy weight are screw fixed.



Lifetime Guarantee

Read more about the Miller Way on millerbathrooms.co.uk



Full-fix 'anti twist' is a fixing system which prevents the accessory from turning when fitted.



Fixing Adhesive £16.50
Fixing Adhesive code no. 8798
Glue always sold separately.
Read more on millerbathrooms.co.uk

LEARN MORE

For detailed measurements please see millerbathrooms.co.uk

Miami is also available in Chrome, Gun Metal and Matt Black finish.

Find coordinating products in our Signature Collection on pages 42-59.



MONTANA

Montana's contemporary styling perfectly accessorises today's modern bathrooms. Crafted from solid brass and hand finished. The range demonstrates a refreshing uniqueness of design. Montana also features the outstanding full-fix system, preventing your products from twisting.



Screws are included. This collection can also be fixed with our Fixing Adhesive.

We recommend that towel rails, glass shelves, mirrors, toilet brush sets, grab bars and products that carry heavy weight are screw fixed.



Lifetime Guarantee

Read more about the Miller Way on millerbathrooms.co.uk



Full-fix 'anti twist' is a fixing system which prevents the accessory from turning when fitted.



Fixing Adhesive £16.50
Fixing Adhesive code no. 8798
Glue always sold separately.
Read more on millerbathrooms.co.uk

LEARN MORE

For detailed measurements please see millerbathrooms.co.uk

Find coordinating products in our Signature Collection on pages 42-59.



Find coordinating products in our Signature Collection on pages 42-59.

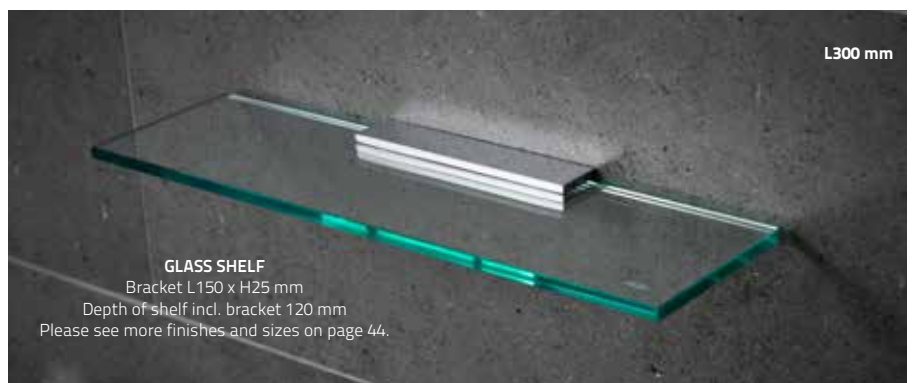

ORLANDO

Sweeping curves, crafted from solid brass and finished in sharp chrome, effortlessly combined with crisp, clean ceramic components are the key features of the Orlando collection. Unquestionably where modern style, combines with full-fix fittings to inspire an imperious range of products.



£116.25

LOTION BOTTLE 8134C
White ceramic
W75 x H175 x D110 mm



£52

ROBE HOOK 8212C
W22 x H115 x D87 mm



£43

HOOK 8211C
W22 x H61 x D68 mm



£71.75

TUMBLER HOLDER 8103C
Tumbler in white ceramic
W80 x H115 x D105 mm



£71.75

SOAP DISH 8104C
Dish in white ceramic
W125 x H40 x D130 mm



Screws are included. This collection can also be fixed with our Fixing Adhesive.

We recommend that towel rails, glass shelves, mirrors, toilet brush sets, grab bars and products that carry heavy weight are screw fixed.



Lifetime Guarantee

Read more about the Miller Way on millerbathrooms.co.uk



'Full-fix 'anti twist' is a fixing system which prevents the accessory from turning when fitted.

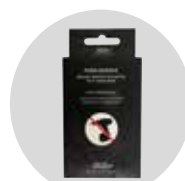

Fixing Adhesive £16.50
Fixing Adhesive code no. 8798
Glue always sold separately.
Read more on millerbathrooms.co.uk

LEARN MORE

For detailed measurements please see millerbathrooms.co.uk

Find coordinating products in our Signature Collection on pages 42-59.

Solid brass in Chrome finish.



OSLO CHROME

Oslo's functional design, created in brass and finished in chrome, combined with its outstanding choice of products has made it the perfect collection for either a contemporary or a traditional setting.



Screws are included. This collection can also be fixed with our Fixing Adhesive.

We recommend that towel rails, glass shelves, mirrors, toilet brush sets, grab bars and products that carry heavy weight are screw fixed.



10 year Guarantee

Read more about the Miller Way on millerbathrooms.co.uk



Fixing Adhesive £16.50
Fixing Adhesive code no. 8798
Glue always sold separately.
Read more on millerbathrooms.co.uk

LEARN MORE

For detailed measurements please see millerbathrooms.co.uk

Find coordinating products in our Signature Collection on pages 42-59.

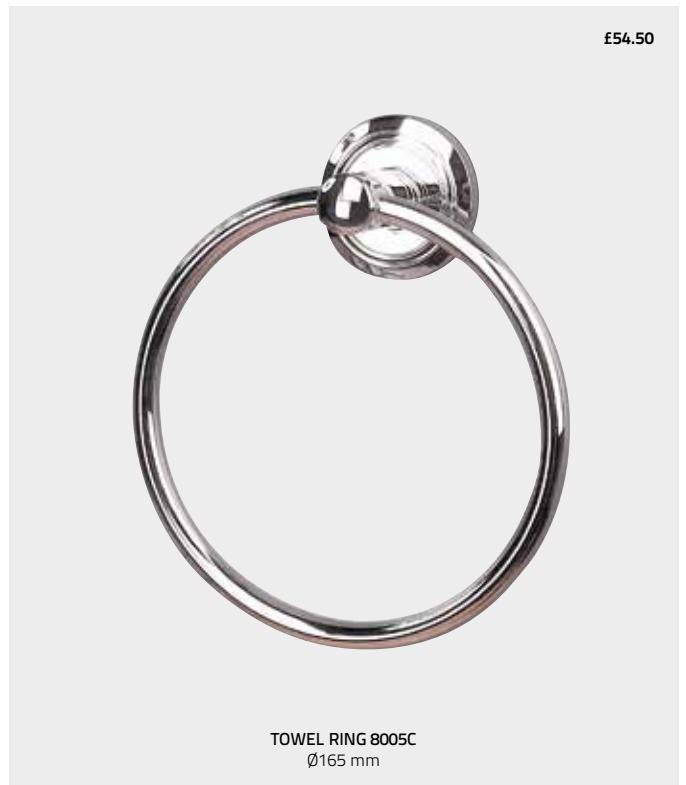
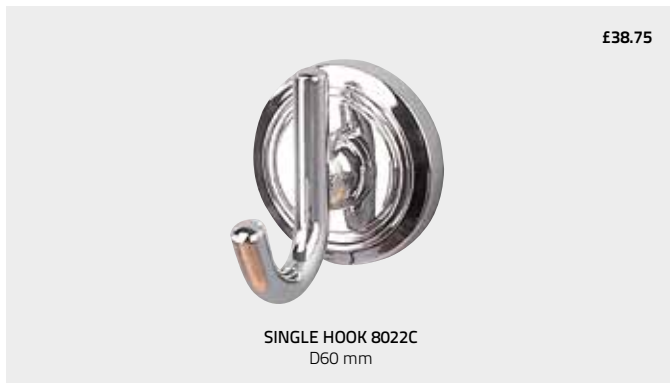

OSLO POLISHED NICKEL

Oslo is a classic range perfect for both contemporary and traditional bathrooms. Crafted from solid brass and finished in a polished nickel finish. Oslo is a range that definitely stands the test of time.

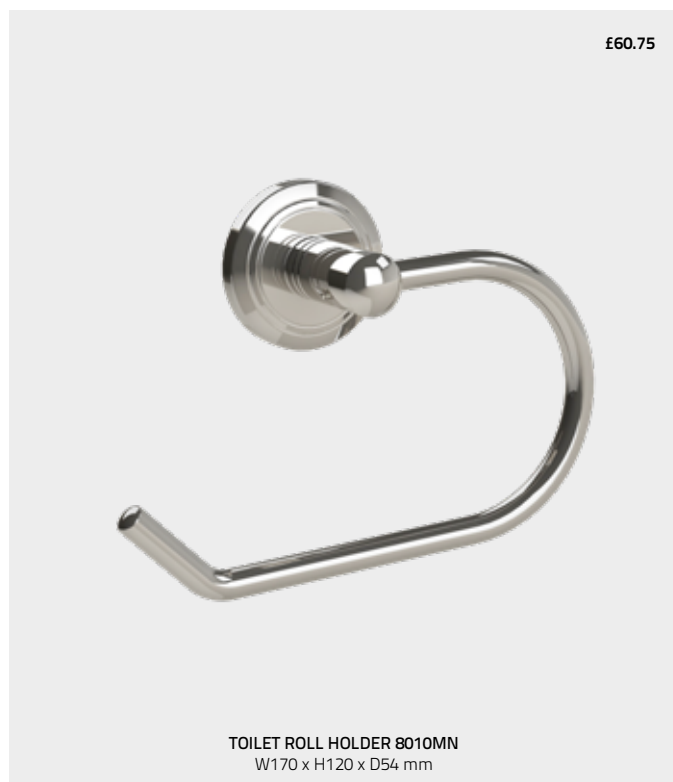

Screws are included. This collection can also be fixed with our Fixing Adhesive.

We recommend that towel rails, glass shelves, mirrors, toilet brush sets, grab bars and products that carry heavy weight are screw fixed.



10 year Guarantee

Read more about the Miller Way on millerbathrooms.co.uk



Fixing Adhesive £16.50
Fixing Adhesive code no. 8798
Glue always sold separately.
Read more on millerbathrooms.co.uk

LEARN MORE

For detailed measurements please see millerbathrooms.co.uk

£39.75



SINGLE HOOK 8022MN
D62 X H65 mm

£60.75



TOWEL RING 8005MN
H190 x W168 x D54 mm

£48.75



DOUBLE HOOK 8023MN
D58 x H62 mm

£177.25



DOUBLE TOWEL RAIL 8027MN
L655 x D150 mm

£95



TOWEL RAIL 8006MN
L505 x D75 mm

£120.50



TOILET BRUSH SET 8021MN
Wall-mounted, white ceramic bowl
H365 x Ø110 mm

£146

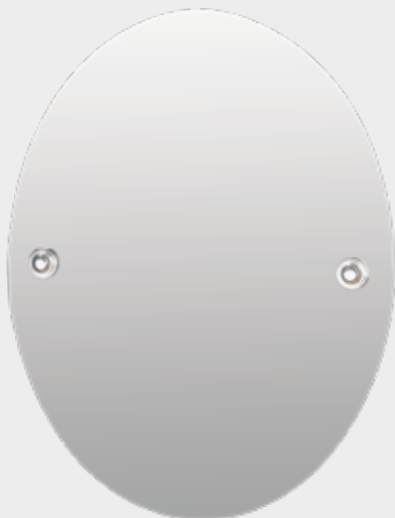

MIRROR 8000MN
Oval mirror W400 x H505 mm
Range mirror is guaranteed for 2 years.

RICHMOND

Richmond's stylish curves combine with modern manufacturing methods to create a perfect fusion. Crafted from solid brass, beautifully finished in hard wearing chrome and perfectly complemented with delicate, white ceramic components, the Richmond collection is truly a classic 'for today'.



£55.25

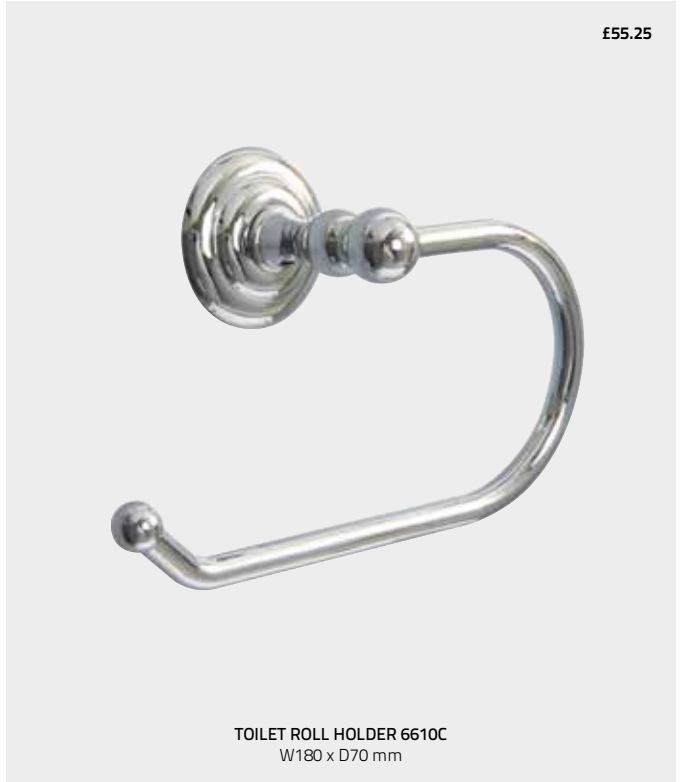

TOILET ROLL HOLDER 6610C
W180 x D70 mm



£60.75

TUMBLER HOLDER 6603C
White ceramic
H110 x D120 mm



£95

DOUBLE POST TOILET ROLL HOLDER 6637C
W220 x D70 mm



£60.75

SOAP DISH 6604C
White ceramic
H65 x D140 mm



Screws are included. This collection can also be fixed with our Fixing Adhesive.

We recommend that towel rails, glass shelves, mirrors, toilet brush sets, grab bars and products that carry heavy weight are screw fixed.



Lifetime Guarantee

Read more about the Miller Way on millerbathrooms.co.uk



Full-fix 'anti twist' is a fixing system which prevents the accessory from turning when fitted.



Fixing Adhesive £16.50
Fixing Adhesive code no. 8798
Glue always sold separately.
Read more on millerbathrooms.co.uk

LEARN MORE

For detailed measurements please see millerbathrooms.co.uk

Find coordinating products in our Signature Collection on pages 42-59.

£37.50



SINGLE HOOK 6622C
D80 mm

£55.25



TOWEL RING 6605C
Ø155 x D70 mm

£48.75



DOUBLE HOOK 6623C
W85 x D70 mm

£162.75



DOUBLE TOWEL RAIL 6627C
L655 x D150 mm

£95



TOWEL RAIL 6606C
L495 x D70 mm Length of rail 425 mm

£124.25



MIRROR 6600C
Bevelled edge,
W410 x H500 mm
Range mirror is guaranteed for 2 years.

£146



GLASS SHELF 6602C
Clear hardened glass
L500 x D125 x H56 mm

STOCKHOLM

Designed and developed in 1978, Stockholm is a timeless combination of classic quality and style. Crafted from solid brass and hand finished, this traditional collection is complemented by ceramic component parts. With its extensive range of products, Stockholm offers the perfect answer for any bathroom setting.



This collection is screwfixed.
Screws are included



Lifetime Guarantee

Read more about
the Miller Way on
millerbathrooms.co.uk

LEARN MORE

For detailed measurements
please see millerbathrooms.co.uk

Find coordinating products in our
Signature Collection on pages 42-59.

Finishes Available 

Chrome finish or selected products in polished untreated brass
White ceramic details

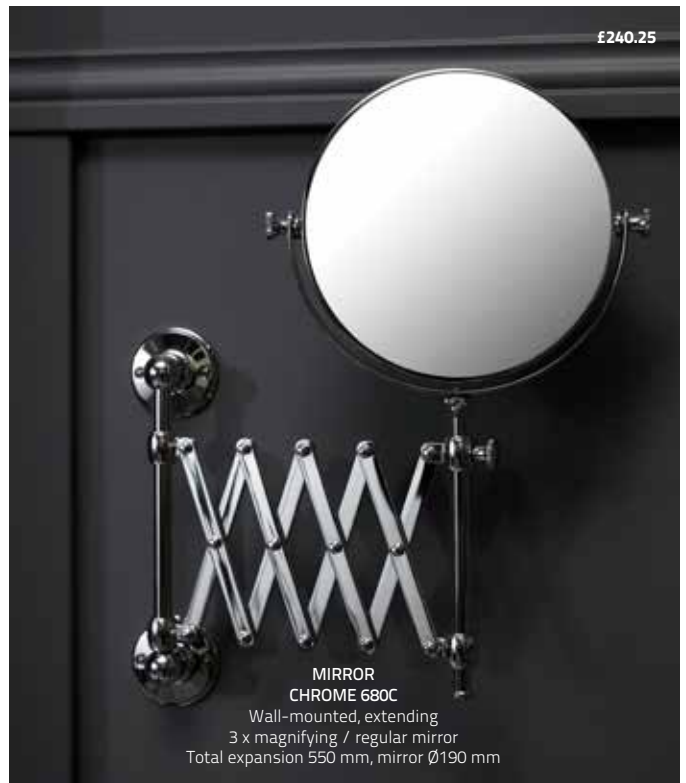
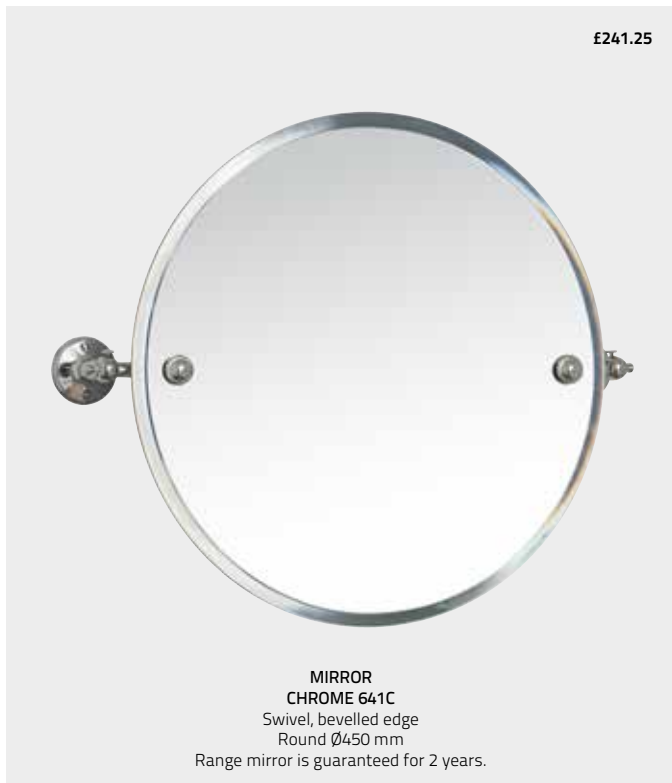

STOCKHOLM



£61.75

TOWEL RING
CHROME 605C
POLISHED BRASS 605MP
Ø145 mm



£205.50

DOUBLE TOWEL RAIL
CHROME 627C
POLISHED BRASS 627MP
L720 x H135 mm

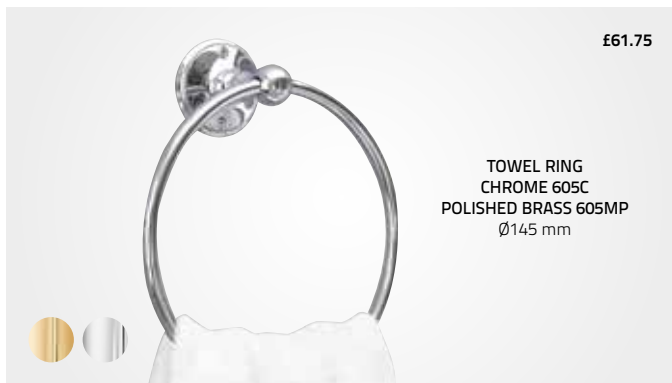

£61.75

TOWEL RING
CHROME 605C
POLISHED BRASS 605MP
Ø145 mm



£185

DOUBLE TOWEL RAIL
CHROME 617C
L545 x H135 mm



£98.25

TOWEL RAIL
CHROME 606C
L545 x H75 mm



£103

TOWEL RAIL
POLISHED BRASS 616MP
L720 mm





£18.25

TOILET SIGN
CHROME 722C
Oval sign, chrome finish
W80 x H45 mm



£18.25

BATHROOM SIGN
CHROME 723C
Oval sign, chrome finish
W80 x H45 mm

Finishes Available  

Chrome finish or selected products in polished untreated brass
White ceramic details



SIGNATURE MIRRORS

£319.75



MIRROR 643C
Framed, polished bevelling, chrome finish
W500 x H700 mm

£344.25



**MIRROR CHROME 642C
POLISHED BRASS 642MP**
Framed swivel, polished bevelling
W545 x H610 mm



£240.25



MIRROR 680C
Wall mounted, 3 x magnification/regular mirror
Max extension 550 mm, Ø190 mm

£121.75



**MIRROR CHROME 681C
POLISHED BRASS 681MP**
Wall mounted, 3 x magnification/regular mirror
Max extension 350 mm, Ø190 mm





Screws are included. Products with this symbol can also be fixed with our Fixing Adhesive.

We recommend that towel rails, glass shelves, mirrors, toilet brush sets, grab bars and products that carry heavy weight are screw fixed.



10 year Guarantee

Read more about the Miller Way on millerbathrooms.co.uk

LEARN MORE

For detailed measurements please see millerbathrooms.co.uk

£85.25



MIRROR 27201C
Wall mounted, 3 x magnification /regular mirror
Ø190 mm



Classic packaging can be easily found through this colour.

The previously called Classic Accessory Collection has now changed name to Signature Collection. A select range of creative and practical products to complement all of our accessory ranges. Designed and developed with careful attention to detail, this diverse collection offers solutions in a stylish and thoughtful way.



SIGNATURE SHELVES

1. CHOOSE A SHELF SIZE

lengths 300, 400, 500 and 600 mm

2. CHOOSE A BRACKET FINISH

finishes Black, Brushed Brass, Polished Untreated Brass, Chrome, Brushed Nickel and Gun Metal

FACTS:

8 mm clear hardened glass

Solid brass bracket in several finishes

Bracket measurement L150 x H25 x D30 mm

Depth of shelf incl. bracket 120 mm



1. CHOOSE A SHELF SIZE



2. CHOOSE A BRACKET FINISH





GLASS SHELF

8 mm hardened clear glass, 2 chrome finished shelf brackets.
Depth of all shelves 114 mm.

- 291020** L300 mm **£57.00**
- 291120** L400 mm **£59.25**
- 291220** L450 mm **£60.25**
- 291320** L500 mm **£61.25**
- 291420** L600 mm **£63.50**

Brackets included



£60.75

CORNER SHELF 292320

8 mm hardened glass, 2 chrome finished shelf brackets. Brackets included.
W200 x D200 mm



£61.75

CORNER SHELF 292020

8 mm hardened glass, 2 chrome finished shelf brackets. Brackets included.
W200 x D114 mm



£106.25

CLOAKROOM SHELF 668C

6 mm hardened glass. Brackets included.
Guard rail in chrome finish
W280 x D145 x H45 mm

SIGNATURE BASKETS

All baskets on this page have concealed screw fixings.
Baskets marked with no-drill symbol can be fixed with our fixing adhesive.
Adhesive is always sold separately, code.no. 8798



D-SHAPED BASKET 866C £92.50
GLUEABLE WALL BRACKETS (PAIR) CG1 £9.75
CHROME FINISH
Suitable for straight wall application, With practical hook
W250 x H80 x D125 mm



£92.50

SCREW FIXED D-SHAPED BASKET 866C
CHROME FINISH
Suitable for straight wall application
With practical hook
W250 x H80 x D120 mm



D-SHAPED BASKET 866B £99.75
GLUEABLE WALL BRACKETS (PAIR) BG1 £9.75
Suitable for straight wall application, With practical hook
W250 x H80 x D125 mm
MATT BLACK FINISH

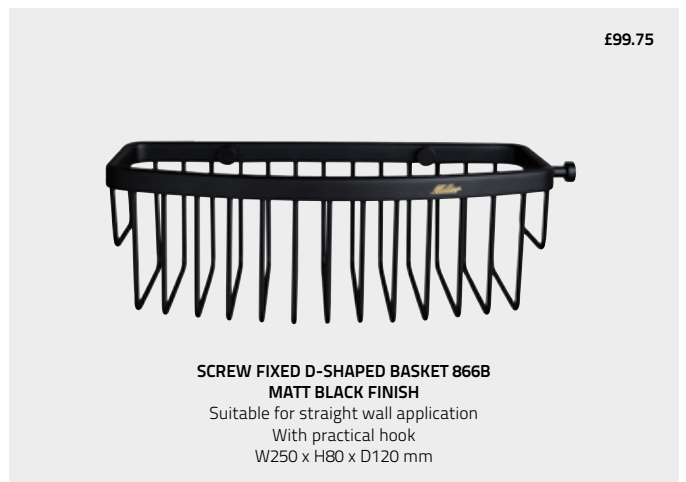

£99.75

SCREW FIXED D-SHAPED BASKET 866B
MATT BLACK FINISH
Suitable for straight wall application
With practical hook
W250 x H80 x D120 mm



D-SHAPED BASKET 866MP £101.75
GLUEABLE WALL BRACKETS (PAIR) MPG1 £9.75
Suitable for straight wall application, With practical hook
W250 x H80 x D125 mm
POLISHED UNTREATED BRASS

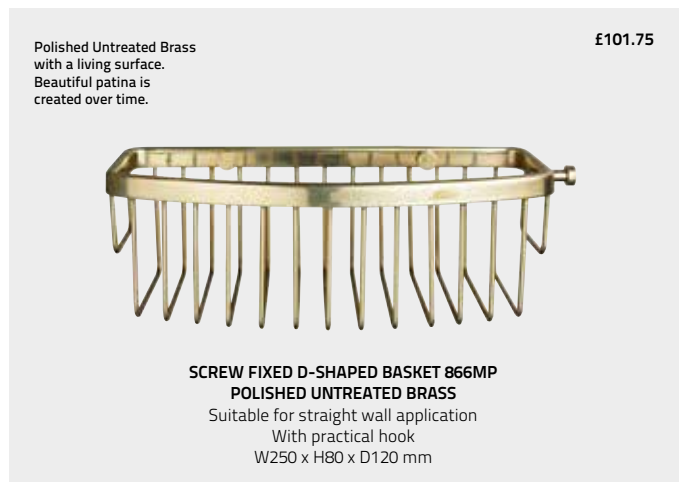

£101.75

SCREW FIXED D-SHAPED BASKET 866MP
POLISHED UNTREATED BRASS
Suitable for straight wall application
With practical hook
W250 x H80 x D120 mm



D-SHAPED BASKET 866MP1 £101.75
GLUEABLE WALL BRACKETS (PAIR) MP1G1 £9.75
Suitable for straight wall application, With practical hook
W250 x H80 x D125 mm
BRUSHED BRASS



£101.75

SCREW FIXED D-SHAPED BASKET 866MP1
BRUSHED BRASS
Suitable for straight wall application
With practical hook
W250 x H80 x D120 mm



Practical Hook on the side

All baskets on this page have concealed screw fixings.
Baskets marked with no-drill symbol can be fixed with our fixing adhesive.
Adhesive is always sold separately, code.no. 8798



GLUE/FIXING ADHESIVE 8798 £16.50
Use our adhesive to fix the
baskets 856-, 866- with wall brackets.
Fixes 2-4 back plates.



GLUEABLE CORNER BASKET 856C £92.50
GLUEABLE WALL BRACKETS (PAIR) CG1 £9.75
CHROME FINISH
With practical hook
W235 x H80 x D175 mm

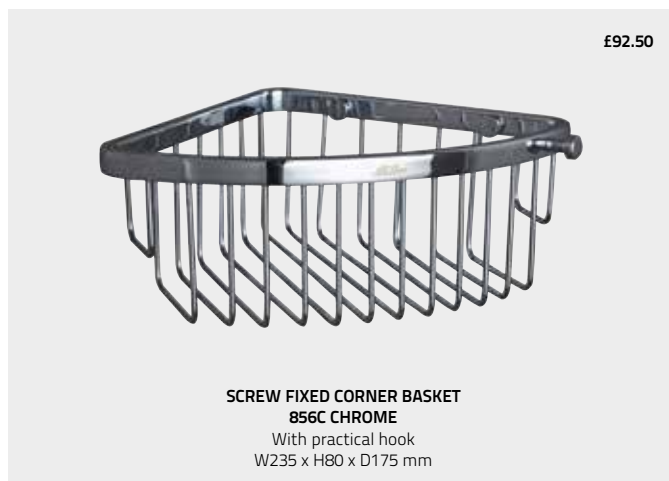

SCREW FIXED CORNER BASKET
856C CHROME
With practical hook
W235 x H80 x D175 mm

£92.50



GLUEABLE CORNER BASKET 856B £99.75
GLUEABLE WALL BRACKETS (PAIR) BG1 £9.75
With practical hook
W235 x H80 x D175 mm
MATT BLACK FINISH

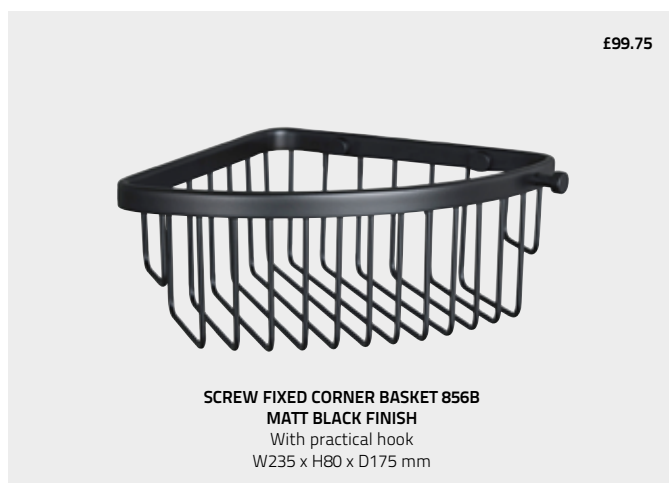

SCREW FIXED CORNER BASKET 856B
MATT BLACK FINISH
With practical hook
W235 x H80 x D175 mm

£99.75



Polished Untreated Brass
with a living surface.
Beautiful patina is
created over time.

GLUEABLE CORNER BASKET 856MP £101.75
GLUEABLE WALL BRACKETS (PAIR) MPG1 £9.75
With practical hook
W235 x H80 x D175 mm
POLISHED UNTREATED BRASS



SCREW FIXED CORNER BASKET 856MP
POLISHED UNTREATED BRASS
With practical hook
W235 x H80 x D175 mm

£101.75

Polished Untreated Brass
with a living surface.
Beautiful patina is
created over time.



GLUEABLE CORNER BASKET 856MP1 £101.75
GLUEABLE WALL BRACKETS (PAIR) MP1G1 £9.75
With practical hook
W235 x H80 x D175 mm
BRUSHED LACQUERED BRASS



SCREW FIXED CORNER BASKET 856MP1
BRUSHED LACQUERED BRASS
With practical hook
W235 x H80 x D175 mm

£101.75

SIGNATURE BASKETS

All baskets on this page have concealed screw fixings. Baskets marked with no-drill symbol can be fixed with our fixing adhesive. **Adhesive is always sold separately.**

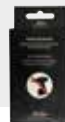

GLUE/FIXING ADHESIVE 8798 £16.50
Use our adhesive to fix the baskets 856-, 866- with wall brackets. Fixes 2-4 back plates.



CORNER SOAP BASKET 851C £70.25
Chrome finish
With practical hook
W185 x H35 x D130 mm



CORNER BASKET 855C £179.25
GLUEABLE WALL BRACKETS (PAIR) CG1 £9.75
2 packs of brackets required
Chrome finish
With practical hook
W235 x H310 x D175 mm



CORNER BASKET 855MP1 £202.50
GLUEABLE WALL BRACKETS (PAIR) MP1G1 £9.75
2 packs of brackets required
Brushed Brass finish
With practical hook
W235 x H310 x D175 mm



CORNER BASKET 855B £196
GLUEABLE WALL BRACKETS (PAIR) BG1 £9.75
2 packs of brackets required
Matt Black finish
With practical hook
W235 x H310 x D175 mm



D-SHAPED BASKET 865C £170.50
GLUEABLE WALL BRACKETS (PAIR) CG1 £9.75
2 packs of brackets required
With practical hook, Chrome finish
Suitable for straight wall application, two tier
W250 x H310 x D120 mm



£338.50

CORNER SHOWER BASKET 875C
Three tier
With practical hook
W235 x H540 x D175 mm
Height of baskets 80 mm

All baskets on this page have concealed screw fixings.

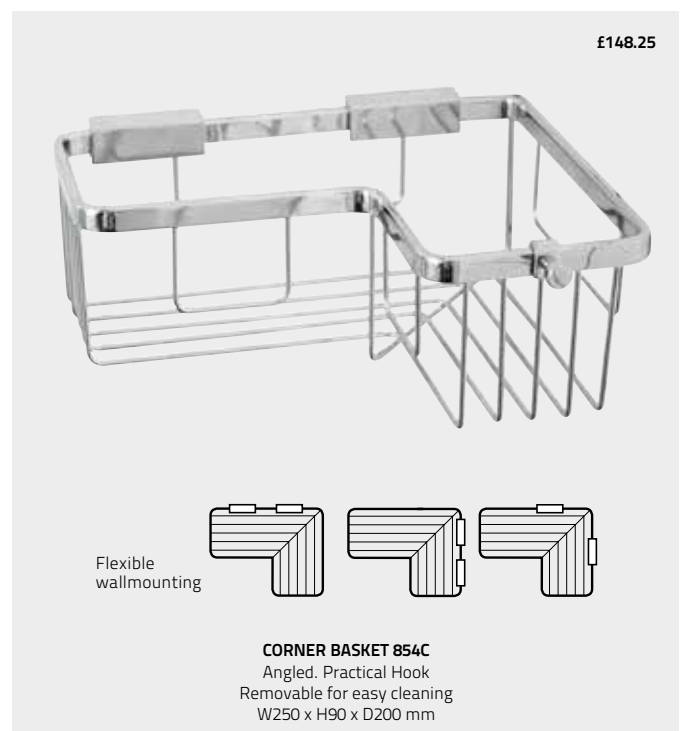

SIGNATURE BASKETS

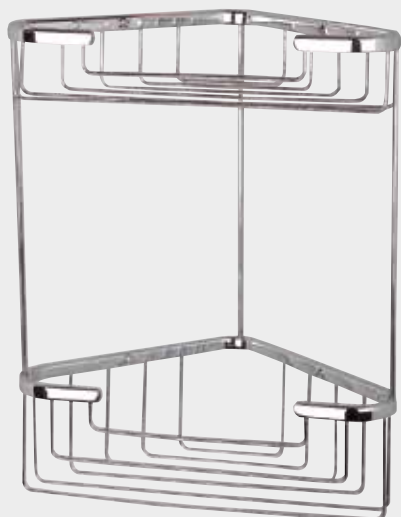

CORNER BASKET 654C £79.50

Two tier, brass, chrome finish
W175 x D115 x H210 mm

CORNER BASKET 655C £107.50

Two tier, brass, chrome finish
W250 x D150 x H310 mm



CORNER BASKET 656C

Brass, chrome finish
W250 x D150 x H80 mm

£55.25



SOAP BASKET 650C
Brass, chrome finish
W130 x D95 x H35 mm

£36.25



CORNER BASKET 652C

Brass, chrome finish
W250 x D150 x H55 mm

£47.50



CORNER BASKET 651C
Brass, chrome finish
W175 x D115 x H35 mm

£36.25

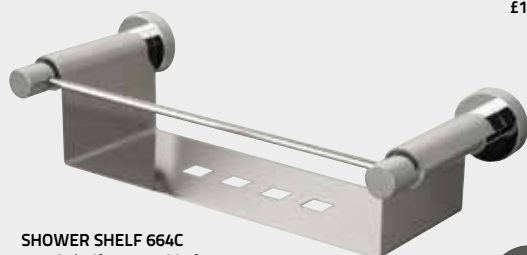

SHOWER SHELF 664C
Stainless steel shelf, removable for easy cleaning. Can also be fixed to the wall with adhesive, sold separately code.no 8798
W315 x D130 x H85 mm

£141.75



BASKET 653C
Brass, chrome finish
W265 x D125 x H45 mm

£72.75

All baskets on this page have concealed screw fixings.

£119.50

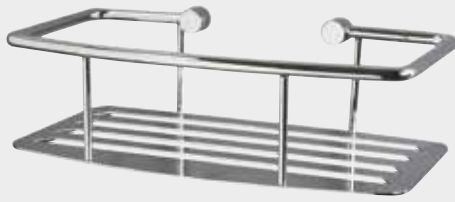

D-SHAPED SHOWER SHELF 870C
Suitable for straight wall application
W250 x H70 x D120 mm

£119.50

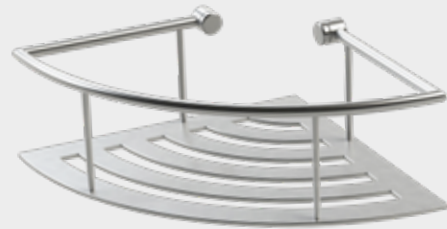

CORNER SHOWER SHELF 862C
W280 x H70 x D200 mm

£245.25



**D-SHAPED 2-TIER
SHOWER BASKET 871C**
Suitable for straight wall application
W250 x H310 x D120 mm

£232.50



**CORNER 2-TIER
SHOWER SHELF 863C**
W280 x H310 x D200 mm

£276.75



SHOWER CADDY 872C
Two tier. No fixing needed.
W235 x H650 x D125 mm
Height between baskets 250 mm

£276.75



SHOWER CADDY 663C
Chrome finish
Two tier. No fixing needed.
W235 x H650 x D125 mm
Height of baskets 80 mm

SIGNATURE BASKETS

All baskets on this page have concealed screw fixings.
Baskets marked with no-drill symbol can be fixed with our fixing adhesive.
Adhesive is always sold separately, code.no. 8798



All baskets on this page have concealed screw fixings.



SIGNATURE FREE STANDING





PAPER ROLL HOLDER
BRUSHED BRASS 5658MP1 £139.25
POLISHED BRASS 5658MP £119.50
CHROME 5658CH £119.50
 With lid
 Ø190 x H610 mm



SPARE ROLL HOLDER
BRUSHED BRASS 5659MP1 £91.75
POLISHED BRASS 5659MP £83
CHROME 5659CH £83
 Fits 3 rolls
 Ø130 x H480 mm



TOILET BRUSH HOLDER
BRUSHED BRASS 5638MP1 £121.75
POLISHED BRASS 5638MP £110.75
CHROME 5638C £110.75
 Ceramic Bowl
 Ø130 x H480 mm

£116.25

Parts included
(image show 648B)

Bracket with supplied tape
(image show 648B)

When mounted on a wall
the holder angles outwards

FREE STANDING OR WALL HUNG (removable)
TOILET BRUSH SET 648B
 Fix with screws or supplied tape. Spare Brush Head incl.
 Matt Black finish
 Ø85 x H380 mm

£107.50

Parts included
(image show 648B)

Bracket with supplied tape
(image show 648B)

When mounted on a wall
the holder angles outwards

FREE STANDING OR WALL HUNG (removable)
TOILET BRUSH SET 648C
 Fix with screws or supplied tape. Spare Brush Head incl.
 Chrome finish
 Ø85 x H380 mm

SIGNATURE OTHER



GRAB BAR

Concealed fixing Ø25 mm

5670C	L360 mm Chrome finish	£87.25
5670B	L360 mm Matt Black finish	£95.00
5670MP1	L360 mm Brushed Brass finish	£98.25
5671C	L460 mm Chrome finish	£92.00
5672C	L560 mm Chrome finish	£99.75



TOWEL HORSE 646C
Free standing
W670 x D290 x H900 mm



TOWEL HOLDER 5669CH
Free standing, Base 180 x 245 mm
Total W373 mm Total H860 mm



BATH RACK 662C
Chrome finish with white rubber details
W720 mm expand to 940 mm x D200 mm



£18.75



BATHROOM SIGN 723C
Oval sign, chrome finish
W80 x H45 mm

£18.75



TOILET SIGN 722C
Oval sign, chrome finish
W80 x H45 mm



FOUR TIER SHELF 27054

£498.25



FOUR TIER SHELF 27054
4 clear glass shelves, Chrome finish
W350 H990 D280 mm

SIGNATURE OTHER



£59.75

SHOWER DOOR & SCREEN FITTING 4-HOOK 832B
 Matt Black finish
 Suitable for glass thickness up to 10 mm
 L181 x D50 x H30 mm



£56.50

SHOWER DOOR & SCREEN FITTING 4-HOOK 832C
 Chrome finish
 Suitable for glass thickness up to 10 mm
 L181 x D50 x H30 mm



£71.75

SHOWER FOOT REST 649B
 For corner use.
 Can also be used as grab bar.
 Matt Black finish with transparent anti-slip rubber rings.
 L350 x Ø22/28 mm



£67.50

SHOWER FOOT REST 649C
 For corner use.
 Can also be used as grab bar.
 Chrome with transparent anti-slip rubber rings.
 L350 x Ø22/28 mm

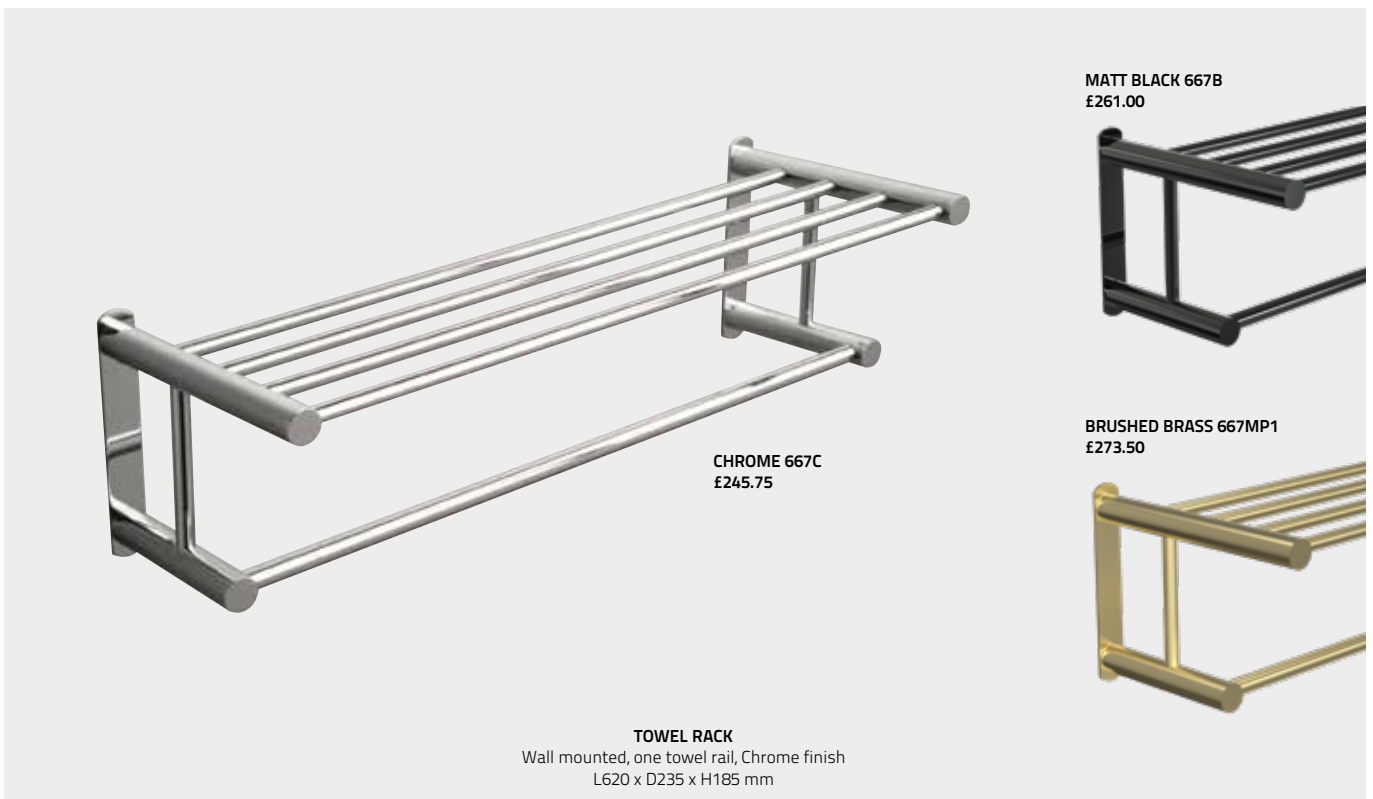

CHROME 667C
 £245.75

MATT BLACK 667B
 £261.00



BRUSHED BRASS 667MP1
 £273.50

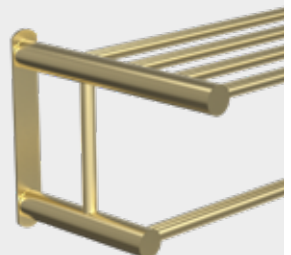

TOWEL RACK
 Wall mounted, one towel rail, Chrome finish
 L620 x D235 x H185 mm

SIGNATURE LIGHT PULLS

The Classic Light Pull Collection is both stylish yet practical. Manufactured from solid brass with several products featuring complementary ceramic or wood parts, all these pulls are supplied with white cord for easy fitting.

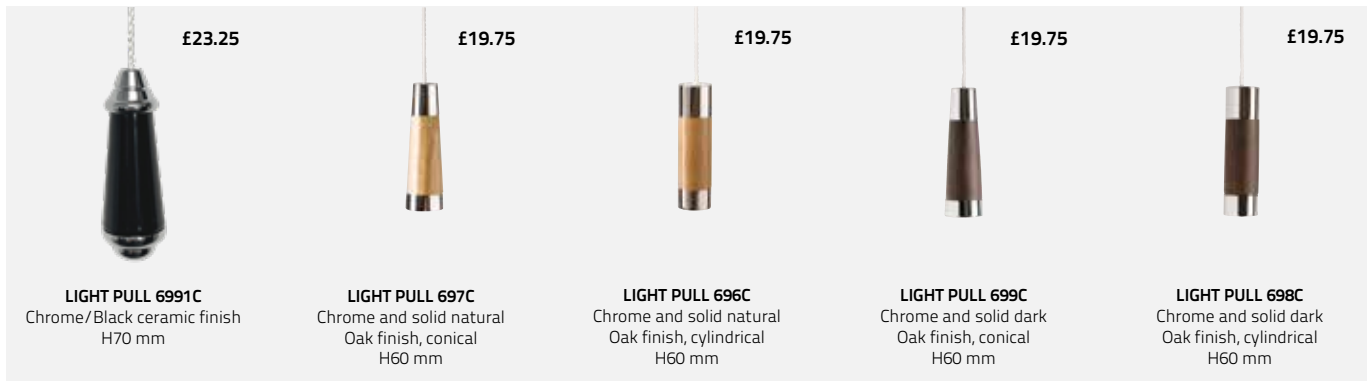
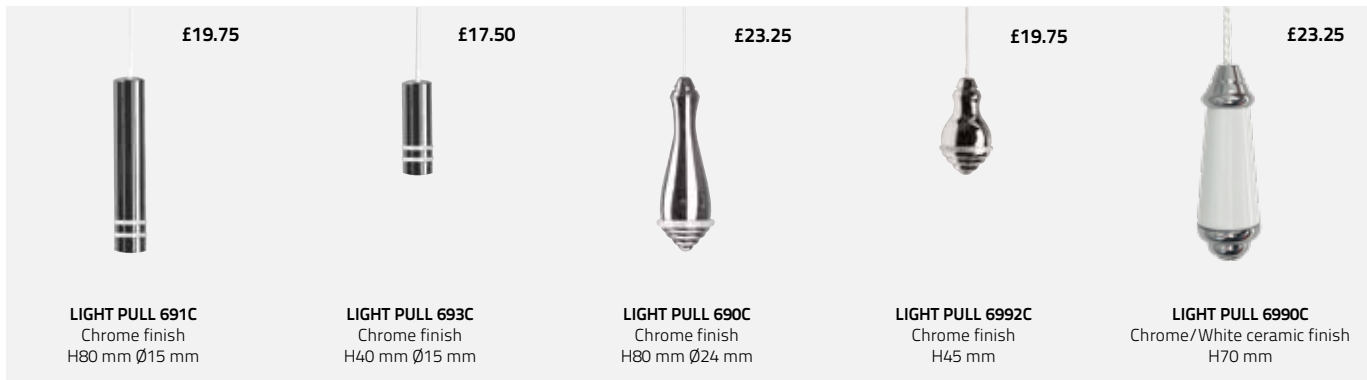

CUBE

Backplate 60 x 60 mm, Chrome finish



Glass Shelf C02
Clear Glass
L500 x D140 mm

£48.25



Soap Dish C04
Clear glass
H60 x D130 mm

£25.25



Lotion Bottle C34
Frosted glass
H160 x D110 mm

£34.25



Tumbler Holder C03
Clear glass
H110 x D110 mm

£25.25



Towel Ring C05
Ø155 mm
H180 x D55 mm

£23.25



Double Hook C23
D55 mm

£18.75



Towel Rail C06
Length of rail 430 mm
L505 x D70 mm

£37.50



Single Robe Hook C11
D55 mm

£16.50



Toilet Roll Holder C10
W170 x H110 mm

£23.25



Screws are included.
This collection can also be fixed with our Fixing Adhesive.

We recommend that towel rails, glass shelves, mirrors, toilet brush sets, grab bars and products that carry heavy weight are screw fixed.



2 year Guarantee

Read more about the Miller Way on millerbathrooms.co.uk



Fixing Adhesive £16.50
Fixing Adhesive code no. 8798
Glue always sold separately.
Read more on millerbathrooms.co.uk

LEARN MORE

Find coordinating products in our Signature Collection on pages 42-59.

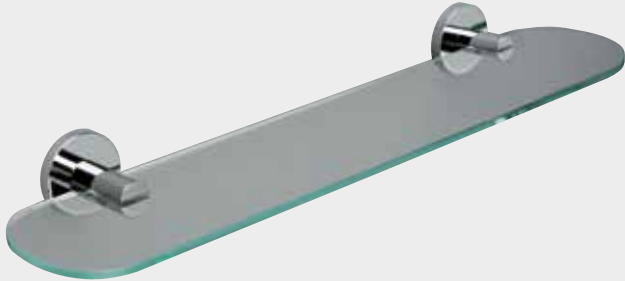

Glass Shelf L02
Clear Glass
L500 x D125 mm

£48.25



Soap Dish L04
Clear glass, Ø110 mm
H60 x D130 mm

£25.25



Lotion Bottle L34
Frosted glass
H170 x D110 mm

£34.25



Tumbler Holder L03
Clear glass
H95 x D105 mm

£25.25



Towel Ring L05
Ø160 mm

£23.25



Double Hook L23
H60 x D55 mm

£18.75



Towel Rail L06
L520 mm

£37.50



Hook L11
H60 x D55 mm

£16.50



Toilet Roll Holder L10
W170 x H110 mm

£23.25



Screws are included.
This collection can also be fixed with our Fixing Adhesive.

We recommend that towel rails, glass shelves, mirrors, toilet brush sets, grab bars and products that carry heavy weight are screw fixed.



2 year Guarantee

Read more about the Miller Way on millerbathrooms.co.uk



Fixing Adhesive £16.50
Fixing Adhesive code no. 8798
Glue always sold separately.
Read more on millerbathrooms.co.uk

LEARN MORE

Find coordinating products in our Signature Collection on pages 42-59.

A good morning. And an equally good night.

The morning is full of anticipation.
At night it is filled by a relaxing calm.
The bathroom has an important role
for all - for both the large and the small
family. Therefore it is important that the
bathroom spreads that extra feeling of
comfort that makes us feel good.

But we are all unique, with different tastes
and needs and desire a bathroom that is
adapted to our own personality. Freedom
of choice from our wide range of bathroom
furniture and accessories gives you the
chance to realise your own dreams.

Miller

Furniture Collections

- 66** City
- 82** Kensington
- 94** New York
- 106** London
- 114** Mirrors and Mirrored Cabinets
- 120** Ambient LED Mirrors
- 122** Classic
- 126** Ceramics
- 129** Taps
- 131** Handles and Knobs



Material, Care and Fixing Guides

Can be found at millerbathrooms.co.uk

City 66



40, 60, 80, 100, 120 and 160 cm
Midnight Blue, Charcoal Black,
Highland Green, Thunder Grey, Coffee
and Cotton Cream.

Kensington 82



60, 80 and 100 cm
Classic framed fronts and drawers
Dark Grey and White.

New York 94



40, 60, 80, 100, 120 and 160 cm
Grain effect doors and drawers in Light and
Dark Oak. White comes in a smooth finish.
Light Oak, Dark Oak and plain White.

London 106



40, 60, 80, 100, 120 and 160 cm
Framed fronts and drawers
Natural Oak

Mirror Cabinets 114



Technically powerful LED light creates
illuminated lines with better colour
reproduction. Perfect for makeup.

Mirrors 120



Several shapes of dimmable LED with
indirect light. Controlled with touch-
sensor. With or without bevelled edge.

Classic 122



55 and 65 cm
Classic hand made English white ceramic
Mirror and Bathroom Cabinet.

Ceramic 126 / Taps 129



Full cover basins in several sizes: up to 160
cm wide. Free standing basins in several
shapes. Gloss and Matt White, Cotton and
Coffee Cream.

Toilets 127



Wall hung or freestanding Toilets in 4 select
colours. Gloss and Matt White, Cotton and
Coffee Cream.

Higher standard Guaranteed

It's difficult to explain the feeling, when something feels really good inside and out. We constantly work on improving the small details which ultimately makes our bathroom furniture better.

Details that might not always be visible but after years of use the feeling becomes obvious. Miller offers a guaranteed higher standard without adding extra. Room for feelings – the Miller Way.



Open and close to feel the quality. We use only the best rails and fittings with our furniture.



Edges and fronts of both drawers and doors are of 19 mm thickness. This gives a solid and longer lasting impression.



Mirror Cabinets and Mirrors in several sizes with efficient, elegant and dimmable LED lighting.



Vanities with drawers have a larger bottom drawer and a slightly lower top drawer. It's both practical and more visually beautiful than having two equally size drawers.



The hinges on the double sided mirror doors are fully adjustable in all directions and soft closing.



Genuine ceramic of highest quality. See page 126 for several options of full cover basins.



Conscious choices of material give you a sustainable product with the best finish.



Fully extendable, soft closing drawers. Dividers made from solid oak. Anti-slip mats and straight insides gives you optimal storage.



Plenty of options for optimal storage.

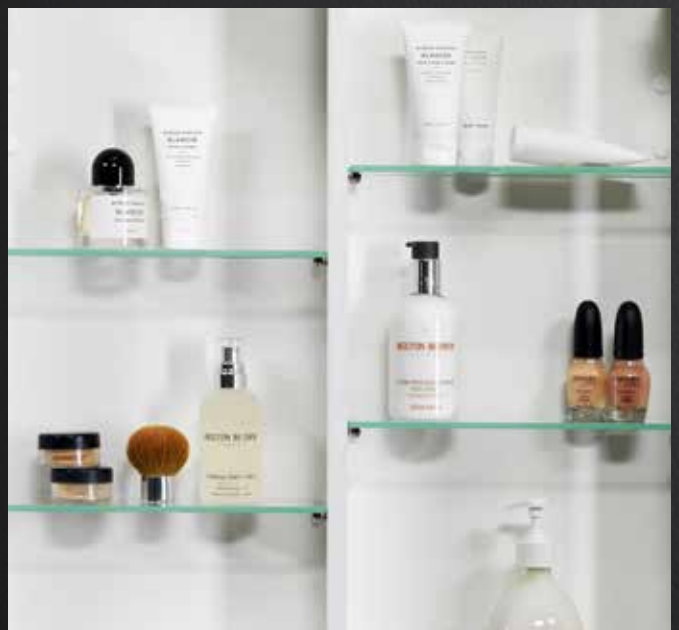

Centre divider in our bathroom cabinets gives stability and flexibility when it comes to the placement of the shelves.

CITY

40, 60, 80, 100, 120 and 160 cm

Smooth doors and drawers

Silk matt surface



Feel the surface - soft and smooth to the touch, Fingerprint free and scratch proof. Made from an attractive, strong, high density material using the latest Nano-technology. The surface density is the key to the colour, finish and strength of the City range - both beautiful and sustainable.

Pictures only tell half the story for City, visit one of our displaying dealers to feel the difference. See for yourself the long lasting, colour fast, smooth finish.

Available in 6 on-trend colours - we invite you to choose yours, built to last a lifetime.

City 80
Ambient Mirror 90
City Vanity 80 Coffee Cream
Edge 80 basin Coffee Cream
Tap 1943B
Wall hung toilet Coffee Cream
Accessories Bond/Classic



Drawer Vanity City 80 Coffee Cream with ceramic basin Edge 80. Tap 1943B. Accessories Bond Black. Wall hung Toilet 190-WC50-54 colour matched with our City Vanity.



Drawer Vanity City 80 Coffee Cream with matching Worktop and colour matched Ceramic Basin 130-R40-54. Tap 1941C.



Drawer Vanity 80 Coffee Cream with full cover basin Bloc 111-80X46-01. Matching Ceramic Waste 110-190-01. Tap 1943C.



Drawer Vanity City 80 Cotton Cream with matching Worktop and Ceramic Basin Cylinder Gloss White. Tap 1941C.



Drawer Vanity City 80 Cotton Cream with matching Worktop and colour matched Ceramic Basin Bowl Cotton Cream. Tap 1941C.



Fully extendable drawers. City 60 drawer vanity Cotton Cream with colour matched basin Edge in Cotton Cream.



Vanity with drawers City 60 Cotton Cream with Basin Edge in Cotton Cream. Wall hung Toilet in colour matched Cotton Cream ceramic. Ambient LED Mirror 70 cm.



From the left: **Highland Green door vanity 40** 784H-6T, worktop 779-6, basin 135W, tap 1941MP, linear LED mirror 59L, knob 50886. **Midnight Blue door vanity 40** 784H-3T, worktop 779-3, basin 135W, tap 1941C, simple mirror glass 59-G + LED lighting L102, knob 93810. **Thunder Grey door vanity 40** 784H-9T, worktop, basin 174W1, tap 1940B, linear LED mirror cabinet 752HL-9, knob 50887.



Drawer Vanity 100 Midnight Blue with Edge Basin 110-100x46-51, tap 1940MP, Linear LED Mirror Cabinet 755L-3, Down Light DL2. Tall Cabinet 795H-3.



Drawer Vanity 80 Charcoal Black with full cover basin Edge 80, tap 1940B, linear LED mirror cabinet 754L-4 with down light DL2. Storage Cabinet 796H-4. Accessories Atlanta.



Stunning Highland Green colour with a thin genuine ceramic basin Edge.

Soft closing drawers and doors. The drawers are sturdy, fully expandable and fitted with anti-slip mats. Vanity unit top drawers have compartments in solid oak that can be easily removed for cleaning. Vanity bottom drawers are fitted with an adjustable bar to stop larger products from moving.

Complete the look with our range of taps and handles to add your own finished character to the bathroom furniture.

The furniture is delivered fully assembled.

For your vanity you can choose between a full cover basin, stone worktop with integrated basin or a worktop with basin. See options below.

Colours



Drawer Vanities in five ways:

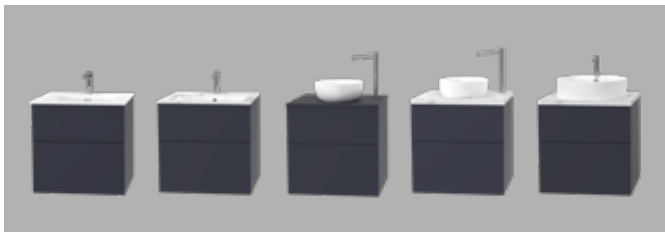

1. Drawer Vanity with full cover basin
2. Drawer Vanity with stone worktop and integrated ceramic basin
3. Drawer Vanity with wood worktop, basin and free standing tap
4. Drawer Vanity with stone worktop, basin and free standing tap
5. Drawer Vanity with worktop, basin and tap

Door Vanities in two ways:

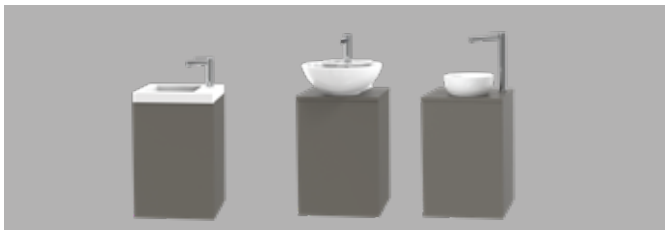

1. Door Vanity with full cover basin, only 35 cm deep
2. Door Vanity with worktop and basin

Worktops Stone 30 mm



Full Cover Ceramic Basins



Stone Worktops with Integrated Ceramic Basin

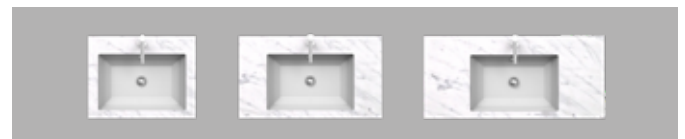

Basins for worktop, tap mounted on the basin



Basins for worktop, tap mounted on the work top



Worktops Wood

City laminate Worktop 18 mm



DETAILS CITY

Symbol shows that this feature is optional. **T**



Fully extendable, soft closing drawers. Lower vanity drawers are equipped with an adjustable retaining bar that keeps bottles in place.



Top Drawer is equipped with a removable divider in solid oak.



Anti slip mats in vanity units and storage cabinet drawers.



Pad. Drawer fronts and doors have partially milled pads in rubber that stays in place.



Smooth surface
Feel it – the silky-smooth surface is both nice to the touch and lovely to look at.

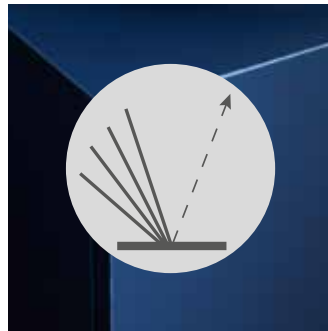

Matt surface
The matt surface reflects a minimum of light and creates a soft effect in your bathroom.



Scratch resistant material
The material surface offers the most scratch resistant surface Nano-technology can offer increased wear resistance offers longer use and sustainability.



Anti-fingerprint
The special surface used is dirt and water repellent and fingerprint free.



Our bathroom furniture has a guarantee. Read more on millerbathrooms.com



Matching worktop. Thanks to the durable surface used in our City bathroom collection, we can now offer colour matched worktops.

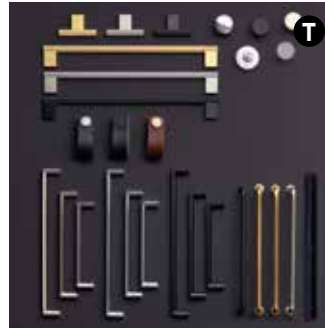

Handles and knobs. Choose between various finishes, shapes and sizes to create your personal touch. **Page 131.**



Linear LED Mirror Cabinets in matching City colours.

CITY

Vanity units are fitted with mounting rails and brackets for easy adjustment and quick installation. Drawer fronts are adjustable in all directions. Fully extending drawers with soft close mechanism.

The drawers include an anti slip mat and removable wooden dividers in solid oak.

Lower drawers in vanities are equipped with a retaining bar. Vanity units, basins, taps and handles are priced separately.

Choose between full cover basin, stone work top with integrated basin or work top with basin. All furniture is delivered fully assembled.

Read more about the Miller Way on www.millerbathrooms.co.uk

Choose colour

For Vanity colour choose colour code and replace -X



Midnight Blue -3



Charcoal Black -4



Highland Green -6



Coffee Cream -7



Thunder Grey -9









Cotton Cream -10

60 / 80 / 100 / 120 / 160

Vanity with full cover ceramic basin

Price separately for vanity, basin and tap.

<p>60 City</p>  <p>Size vanity W594 x H625 x D448 mm Basin size see each model</p>	<p>80 City</p>  <p>Size vanity W794 x H625 x D448 mm Basin size see each model</p>	<p>100 City</p>  <p>Size vanity W994 x H625 x D448 mm Basin size see each model</p>
<p>Vanity unit 2 drawers Choose colour 788-X £1004</p> <p>Optional Push function PTM-2 £180 / for 2 drawers Handles page 131</p>	<p>Vanity unit 2 drawers Choose colour 789-X £1025</p> <p>Optional Push function PTM-2 £180 / for 2 drawers Handles page 131</p>	<p>Vanity unit 2 drawers Choose colour 798-X £1231</p> <p>Optional Push function PTM-2 £180 / for 2 drawers Handles page 131</p>
<p>Basins</p>		
<p>Gloss white ceramic basin for 60 vanity Edge 110-60X46-01 £366 Bloc 111-60X46-01 £438</p> <p>Matt White, Cotton Cream and Coffee Cream ceramic basins available – please see page 126.</p>	<p>Gloss white ceramic basin for 80 vanity Edge 110-80X46-01 £469 Bloc 111-80X46-01 £541</p> <p>Matt White, Cotton Cream and Coffee Cream ceramic basins available – please see page 126.</p>	<p>Gloss white ceramic basin for 100 vanity Edge 110-100X46-01 £572 Bloc 111-100X46-01 £675</p> <p>Matt White, Cotton Cream and Coffee Cream ceramic basins available – please see page 126.</p>
<p>120 City</p>  <p>Size vanity W1188 x H625 x D448 mm Basin size see each model</p>	<p>160 City</p>  <p>Size vanity W1588 x H625 x D448 mm Basin size see each model</p>	<p>Full cover Ceramic Basins in 2 models and 4 colours Colour match our City Vanity colours Cotton Cream and Coffee Cream with Ceramic basins and Toilets.</p>  <p>Edge</p>  <p>Bloc</p> <p>Images of basins in all sizes are available on page 131. Measurements are for guidance only, exact measurement should be measured on the delivered basin.</p>
<p>Vanity unit 4 drawers Choose colour 766-X £2009</p> <p>Optional Push function PTM-2 £180 / for 2 drawers Handles page 131</p>	<p>Vanity unit 2 drawers Choose colour 777-X £2050</p> <p>Optional Push function PTM-2 £180 / for 2 drawers Handles page 131</p>	
<p>Basins</p>		
<p>Gloss white ceramic basin for 120 vanity Edge 110-120X46-01 £778 Bloc 111-120X46-01 £881</p> <p>Matt White, Cotton Cream and Coffee Cream ceramic basins available – please see page 126.</p>	<p>Gloss white ceramic basin for 2 bowls Edge 110-160X46-01 £1293 Bloc 111-160X46-01 £1396</p> <p>Matt White, Cotton Cream and Coffee Cream ceramic basins available – please see page 126.</p>	

40

Door Vanity 40 cm with full cover ceramic basin or worktop with basin

Price separately for vanity, basin and tap.

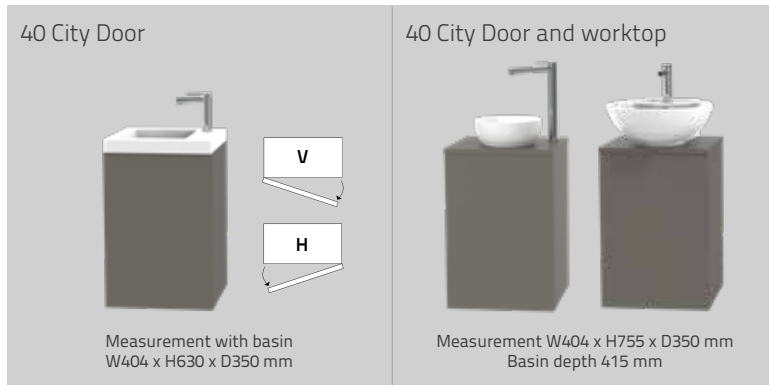

Left hand door vanity
Choose colour **784V-X** £561

Right hand door vanity
Choose colour **784H-X** £561

Basin
White **165W1** £263

Optional
Handles page 131

Left hand door vanity
Choose colour **784V-XT** £561

Right hand door vanity
Choose colour **784H-XT** £561

Basin
White **174W1** £216
White Ø33 **135W** £309

Only suitable basins for 40 vanity with worktop is 174W1 and 135W

Optional
Handles page 131

Basin



More detailed measurements on www.millerbathrooms.co.uk

Only suitable basins for 40 vanity with worktop is 174W1 and 135W

Stone Worktop for vanity 40 City

Stone Worktop 30 mm



Carrara Marble



Jura Limestone

For basin 174W1

30 mm worktop for 40 vanity
Marble **400M** £514
Jura **400J** £514
Measurement W408 x D358 mm



For basin 135W - choose -H/-V

30 mm worktop for 40 vanity
Marble **400M-X** £514
Jura **400J-X** £514
Measurement W408 x D358 mm



Wood Worktop for vanity 40 City

City Laminate 18 mm

18 mm worktop for 40 vanity
Choose colour **779-X** £129

Measurement W408 x D358 mm

Worktop delivered without waste hole.
Punching to be done by installer.



Classic White -2 Midnight Blue -3 Charcoal Black -4



Highland Green -6 Coffee Cream -7 Thunder Grey -9



Cotton Cream -10

Vanity with stone work top and integrated ceramic basin

Price separately for vanity, worktop with integrated ceramic basin and tap.

<p>60 City</p>  <p>Vanity without worktop W594 x H625 x D448 mm</p>	<p>80 City</p>  <p>Vanity without worktop W794 x H625 x D448 mm</p>	<p>100 City</p>  <p>Vanity without worktop W994 x H625 x D448 mm</p>	<p>120 City</p>  <p>Vanity without worktop W1188 x H625 x D498 mm</p>
--	--	--	--

Vanity 2 drawers
Choose colour **788-XT** £1004

Optional
Push function **PTM-2** £180/for 2 drawers
Handles page 131

Vanity 2 drawers
Choose colour **789-XT** £1025

Optional
Push function **PTM-2** £180/for 2 drawers
Handles page 131

Vanity 2 drawers
Choose colour **798-XT** £1231

Optional
Push function **PTM-2** £180/for 2 drawers
Handles page 131

Deep Vanity 4 drawers
Choose colour **766-XTD** £2009

Optional
Push function **PTM-2** £180/for 2 drawers
Handles page 131

Choose stone worktop with integrated ceramic basin

for 60 vanity

Marble **134W/600M** £1750
Jura **134W/600J** £1750
Price incl.integrated ceramic basin
Size worktop W595 x D455 x H30 mm

for 80 vanity

Marble **134W/800M** £1853
Jura **134W/800J** £1853
Price incl.integrated ceramic basin
Size worktop W800 x D455 x H30 mm

for 100 vanity

Marble **134W/1000M** £1956
Jura **134W/1000J** £1956
Price incl.integrated ceramic basin
Size worktop W1000 x D455 x H30 mm

for 120 vanity

Marble **134W/1200M** POR*
Jura **134W/1200J** POR*
Price incl.integrated ceramic basins
Size worktop W1200 x D455 x H30 mm

<p>60</p>  <p>Total size work top W600 x D455 x H30 mm Ceramic W490 x D320 mm Max depth bowl 160 mm</p>	<p>80</p>  <p>Total size work top W800 x D455 x H30 mm Ceramic W490 x D320 mm Max depth bowl 160 mm</p>	<p>100</p>  <p>Total size work top W1000 x D455 x H30 mm Ceramic W490 x D320 mm Max depth bowl 160 mm</p>	<p>120</p>  <p>Total size work top W1200 x D505 x H30 mm Ceramic W490 x D320 mm Max depth bowls 160 mm</p>
--	--	---	---

<p>160 City</p>  <p>Vanity without worktop W1588 x H625 x D498 mm</p>
--

Deep Vanity 4 drawers
Choose colour **777-XTD** £2050

Optional
Push function **PTM-2** £180/for 2 drawers
Handles page 131

for 160 vanity

Marble **134W/1600M** | POR*
Jura **134W/1600J** |

Price incl.integrated ceramic basins
Size worktop W1595 x D455 x H30 mm
*Price on request

<p>160</p>  <p>Total size work top W1595 x D505 x H30 mm Ceramic W490 x D320 mm x 2 bowls Max depth bowls 160 mm</p>

Stone Worktop 30 mm



Carrara Marble

Limestone 30 mm



Jura Limestone

Vanity with wood work top

Price separately for vanity, worktop with integrated ceramic basin and tap.

60 City	80 City	100 City	120 City
			
Vanity without worktop W594 x H625 x D448 mm Basin size see each model	Vanity without worktop W794 x H625 x D448 mm Basin size see each model	Vanity without worktop W994 x H625 x D448 mm Basin size see each model	Vanity without worktop W1188 x H625 x D448 mm Basin size see each model
<i>Vanity 2 drawers</i> Choose colour 788-XT £1004	<i>Vanity 2 drawers</i> Choose colour 789-XT £1025	<i>Vanity 2 drawers</i> Choose colour 798-XT £1231	<i>Vanity 4 drawers</i> Choose colour 766-XT £2009
<i>Optional Push function Handles</i> PTM-2 £180/for 2 drawers page 131	<i>Optional Push function Handles</i> PTM-2 £180/for 2 drawers page 131	<i>Optional Push function Handles</i> PTM-2 £180/for 2 drawers page 131	<i>Optional Push function Handles</i> PTM-2 £180/for 2 drawers page 131
Worktop 18 mm <i>for 60 vanity</i> Choose colour 600-X £160 <i>Size worktop W600 x D455 mm</i>	<i>for 80 vanity</i> Choose colour 800-X £201 <i>Size worktop W800 x D455 mm</i>	<i>for 100 vanity</i> Choose colour 1000-X £242 <i>Size worktop W1000 x D455 mm</i>	<i>for 120 vanity</i> Choose colour 1200-X £304 <i>Size worktop W1200 x D455 mm</i>
	<i>Vanity 4 drawers</i> Choose colour 777-XT £2050	<i>for 160 vanity</i> Choose colour 1600-X £407 <i>Size worktop W1600 x D455 mm</i>	
Vanity without worktop W1588 x H625 x D448 mm Basin size see each model	<i>Optional Push function Handles</i> PTM-2 £180/for 2 drawers page 131		







Matching laminate wood Worktop

Height 18 mm

Worktop delivered without waste hole.
Punching to be done by installer.

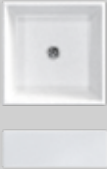





Classic White -2 Midnight Blue -3 Charcoal Black -4 Highland Green -6 Coffee Cream -7 Thunder Grey -9 Cotton Cream -10

Basin for worktop, column tap mounted on the side of the basin		130-R40-01	131-R40-01	133W	132W
130-R40-01 £350 Available in more colours – see page 126	131-R40-01 £350 Available in more colours – see page 126				
133W £324	132W £324	Ø400 x H170 mm Max. depth bowl 150 mm	Ø400 x H165 mm Max. depth bowl 122 mm	Ø390 x H150 mm Max. depth bowl 130 mm	W390 x D390 x H130 mm Max. depth bowl 95 mm
<i>Only column taps are suitable for these washbasins: 1941C, 1941MP, 1941B.</i>					
Basin for worktop, tap mounted on the basin		116W1	171W1	173W1	
116W1 £484	171W1 £308				
173W1 £308		W500 x D495 x H180 mm	Ø460 x H180 mm	W550 x H130 x D450 mm	
<i>Measurements of each basin is available on millerbathrooms.co.uk</i>					

Vanity with work top and basin, tap mounted on the basin

Price separately for vanity, basin and tap.

60 City	80 City	100 City	120 City
			
Vanity without worktop W594 x H625 x D448 mm Basin size see each model below	Vanity without worktop W794 x H625 x D448 mm Basin size see each model below	Vanity without worktop W994 x H625 x D448 mm Basin size see each model below	Vanity without worktop W1188 x H625 x D448 mm Basin size see each model below
<i>Vanity 2 drawers</i> Choose colour 788-XT £1004	<i>Vanity 2 drawers</i> Choose colour 789-XT £1025	<i>Vanity 2 drawers</i> Choose colour 798-XT £1231	<i>Deep Vanity 4 drawers</i> Choose colour 766-XT £2009
<i>Optional</i> Push function Handles PTM-2 £180/for 2 drawers page 131	<i>Optional</i> Push function Handles PTM-2 £180/for 2 drawers page 131	<i>Optional</i> Push function Handles PTM-2 £180/for 2 drawers page 131	<i>Optional</i> Push function Handles PTM-2 £180/for 2 drawers page 131
Worktop <i>Worktop for 60 vanity</i> Marble 600M £639 Jura 600J £639 <i>Size worktop W595 x D455 mm</i> <i>For height see each work top</i>	<i>Worktop for 80 vanity</i> Marble 800M £742 Jura 800J £742 <i>Size worktop W795 x D455 mm</i> <i>For height see each work top</i>	<i>Worktop for 100 vanity</i> Marble 1000M £850 Jura 1000J £850 <i>Size worktop W995 x D455 mm</i> <i>For height see each work top</i>	<i>Worktop for 120 vanity</i> Marble 1200M £1060 Jura 1200J £1060 <i>Size worktop W1185 x D455 mm</i> <i>For height see each work top</i>
	<i>Deep Vanity 4 drawers</i> White 777-XT £2050	<i>Worktop for 160 vanity</i> Marble 1600M Jura 1600J Price on request	
Vanity without worktop W1588 x H625 x D448 mm Basin size see each model below	<i>Optional</i> Push function Handles PTM-2 £180/for 2 drawers page 131	<i>Size worktop W1595 x D455 mm</i> <i>For height see each work top</i>	

Waste and tap hole position

The worktops are pre-cut with tap hole and waste holes as per diagram.

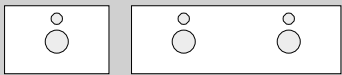

60, 80, 100 120, 160

Stone worktop 30 mm **Limestone 30 mm**
Up to 6 weeks delivery Up to 6 weeks delivery



Carrara Marble Jura

Basin for worktop, tap mounted on the basin

116W1	£484		171W1		173W1	
171W1	£308					
173W1	£308					

Measurements of each basin is available on millerbathrooms.co.uk

W500 x D495 x H180 mm Ø460 x H180 mm W550 x H130 x D450 mm





Choose Vanity Unit Colour -X



Midnight Blue -3 Charcoal Black -4 Highland Green -6 Coffee Cream -7 Thunder Grey -9 Cotton Cream -10

Vanity with work top and basin, column tap mounted on the worktop

Price separately for vanity, basin and tap.

60 City	80 City	100 City	120 City
			
Vanity without worktop W594 x H625 x D448 mm Basin size see each model below	Vanity without worktop W794 x H625 x D448 mm Basin size see each model below	Vanity without worktop W994 x H625 x D448 mm Basin size see each model below	Vanity without worktop W1188 x H625 x D448 mm Basin size see each model below
Vanity 2 drawers Choose colour 788-XT £1004	Vanity 2 drawers Choose colour 789-XT £1025	Vanity 2 drawers Choose colour 798-XT £1231	Deep Vanity 4 drawers Choose colour 766-XT £2009
Optional Push function Handles PTM-2 £180/for 2 drawers page 131	Optional Push function Handles PTM-2 £180/for 2 drawers page 131	Optional Push function Handles PTM-2 £180/for 2 drawers page 131	Optional Push function Handles PTM-2 £180/for 2 drawers page 131
Worktop <i>Worktop for 60 vanity</i> Marble 600M-X £639 Jura 600J-X £639 <i>Size worktop W595 x D455 mm</i> <i>For height see each work top</i>	<i>Worktop for 80 vanity</i> Marble 800M-X £742 Jura 800J-X £742 <i>Size worktop W795 x D455 mm</i> <i>For height see each work top</i>	<i>Worktop for 100 vanity</i> Marble 1000M-X £850 Jura 1000J-X £850 <i>Size worktop W995 x D455 mm</i> <i>For height see each work top</i>	<i>Worktop for 120 vanity</i> Marble 1200M-X £1060 Jura 1200J-X £1060 <i>Size worktop W1595 x D455 mm</i> <i>For height see each work top</i>
	Deep Vanity 4 drawers White 777-X £2050	<i>Worktop for 160 vanity</i> Marble 1600M-X Jura 1600J-X Price on request	
Vanity without worktop W1588 x H625 x D448 mm Basin size see each model below	Optional Push function Handles PTM-2 £180/for 2 drawers page 131	<i>Size worktop W1595 x D455 mm</i> <i>For height see each work top</i>	

Worktop NOTE -X, choose hole pattern, ex. 600M-V is a 60 cm marble worktop with tap hole to the left of the basin
ex. 600J-H is a 60 cm Jura worktop with tap hole to the right of the basin

Waste and tap hole position

Note The tap is placed to the right or to the left of the basin on the worktop. -X, choose hole pattern example 600M-V is a 60 cm Marble worktop with tap hole to the left of the basin.

The worktops are pre-cut with tap hole and waste holes as per diagram.



to the right **-H**

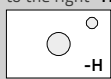

add -H after the worktop code no example: 600M-H



to the left **-V**

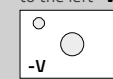

add -V after the worktop code no example: 600M-V

120/160 left + right

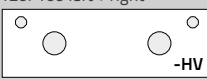

-HV

example: 1600M-HV

120/160 to the left **-V**

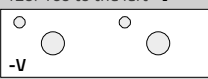

-V

example: 1600M-V

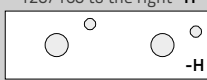

120/160 to the right **-H**



-H

example: 1600M-H

Basin for worktop, column tap mounted on the side of the basin

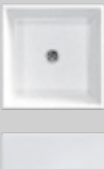

130-R40-01 £350 Available in more colours – see page 126	131-R40-01 £350 Available in more colours – see page 126	133W £324	132W £324
			
Ø400 x H170 mm Max. depth bowl 150 mm	Ø400 x H165 mm Max. depth bowl 122 mm	Ø390 x H150 mm Max. depth bowl 130 mm	W390 x D390 x H130 mm Max. depth bowl 95 mm

Only column taps are suitable for these washbasins: 1941C, 1941MP, 1941B.

STORAGE CITY

Fitted with mounting rails and brackets for easy adjustment and quick installation. Soft closing doors and drawers. V stands for left hand door and H stands for right hand door (see sketch). All furniture is delivered fully assembled.

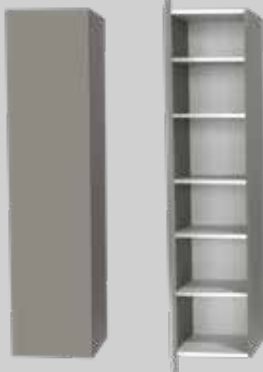
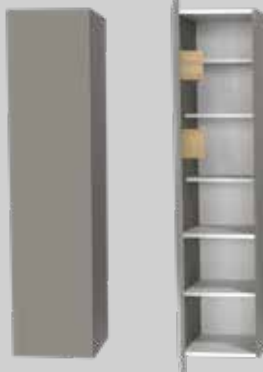
Read more about the Miller Way on www.millerbathrooms.co.uk

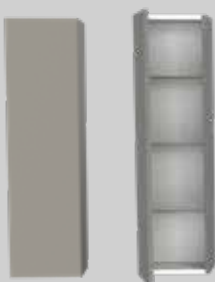
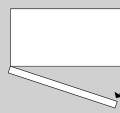
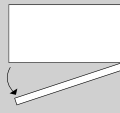
<p>Tall Cabinet</p> <p>1 fixed and 4 adjustable glass shelves</p>  <p>W404 x H1690 x D380 mm</p> <p><i>Left hand door</i> Choose colour 793V-X £1231</p> <p><i>Right hand door</i> Choose colour 793H-X £1231</p> <p><i>Optional</i> Handle page 131</p>	<p>Tall Cabinet with door storage</p> <p>1 fixed and 4 adjustable glass shelves Door storage 2 boxes in solid oak.</p>  <p>W404 x H1690 x D380 mm</p> <p><i>Left hand door</i> Choose colour 794V-X £1437</p> <p><i>Right hand door</i> Choose colour 794H-X £1437</p> <p><i>Optional</i> Handle page 131</p>	<p>Tall Cabinet with door storage and 2 drawers</p> <p>1 fixed and 4 adjustable glass shelves Door storage 2 boxes in solid oak and 2 oak drawers.</p>  <p>W404 x H1690 x D380 mm</p> <p><i>Left hand door</i> Choose colour 795V-X £2009</p> <p><i>Right hand door</i> Choose colour 795H-X £2009</p> <p><i>Optional</i> Handle page 131</p>
<p>Tall Cabinet with 2 drawers</p> <p>1 fixed and 3 adjustable glass shelves, 2 oak drawers.</p>  <p>W404 x H1690 x D380 mm</p> <p><i>Left hand door</i> Choose colour 792V-X £1591</p> <p><i>Right hand door</i> Choose colour 792H-X £1591</p> <p><i>Optional</i> Handle page 131</p>	<p>Storage Cabinet</p> <p>3 adjustable glass shelves</p>  <p>W304 x H1111 x D255 mm</p> <p><i>Left hand door</i> Choose colour 796V-X £716</p> <p><i>Right hand door</i> Choose colour 796H-X £716</p> <p><i>Optional</i> Handle page 131</p>	<p>Right or left hand door?</p>  <p>V = Left hand door</p>  <p>H = Right hand door</p> <p>Choose between a right or left hand door on your storage cabinet. See sketch above. V is for left hand door and H is right hand door in the code no.</p> <p>We do not offer "Push Function" for our storage cabinets.</p>

Colours

Choose Storage Unit Colour -X



Midnight Blue -3

Charcoal Black -4

Highland Green -6

Coffee Cream -7

Thunder Grey -9

Cotton Cream -10



Tall Cabinet 40 cm
795H-3
Midnight Blue



Storage Cabinet 30 cm
796H-6
Highland Green

OPTIONAL

Handle



Handles and knobs. Choose between various finishes, shapes and sizes to create your personal touch. See page 131.

MIRROR CABINET LINEAR LED CITY

Integrated dimmable light with touch sensor. Technically powerful LED light creates illuminated lines with better colour reproduction. Perfect for makeup. Linear LED cabinets are dimmed via the touch sensor on the mirror cabinet, not via dimmers on the wall. IP44 rated.

Fitted with mounting rails and brackets for adjustable & quick installation. Soft closing double sided mirror doors. Choose left or right hand door for the 40 bathroom cabinet, see illustration below. All furniture is delivered fully assembled.

Read more about the Miller Way on www.millerbathrooms.co.uk

40 / 60 / 80 / 100

Colours



Midnight Blue -3

Charcoal Black -4

Highland Green -6

Coffee Cream -7

Thunder Grey -9

Cotton Cream -10

40 City Linear LED

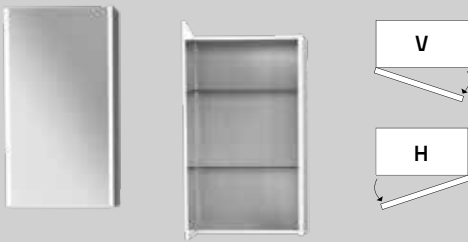

W404 x H700 x D145 mm

2 x glass shelves, IP44

Left hand door

Choose colour **752VL-X** £695

Right hand door

Choose colour **752HL-X** £695

Optional

Down Light **DL2** £81

2 extra glass shelves **54-190** £22

60 City Linear LED

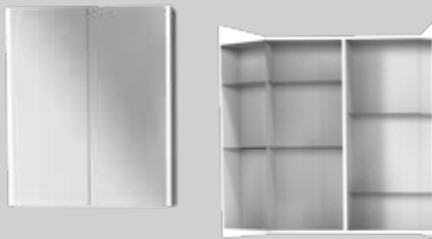

W594 x H700 x D145 mm

4 x glass shelves, centre wood divider, IP44

Choose colour **753L-X** £870

Optional

Down Light **DL2** £81

2 extra glass shelves **53-190** £20

80 City Linear LED

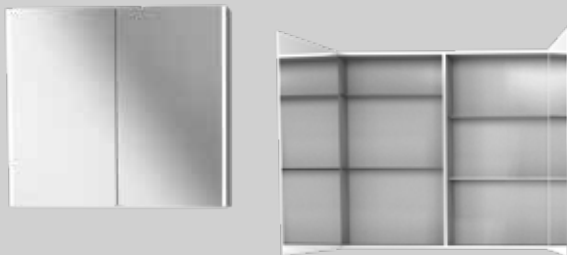

W794 x H700 x D145 mm

4 x glass shelves, centre wood divider, IP44

Choose colour **754L-X** £953

Optional

Down Light **DL2** £81

2 extra glass shelves **54-190** £22

100 City Linear LED

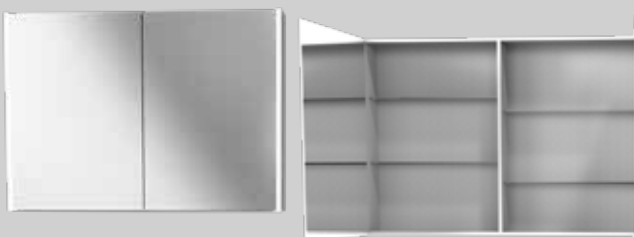

W994 x H700 x D145 mm

4 x glass shelves, centre wood divider, IP44

Choose colour **755L-X** £1004

Optional

Down Light **DL2** £81

2 extra glass shelves **55-190** £24

The inside of all cabinets is white.

MIRROR CABINET LINEAR LED CITY

Details



Centre divider in wood for stability and a more flexible placement of the shelves.



Control the brightness with a touch sensor. Our new Bathroom Cabinet memorises the latest desired brightness when switched on and off.



The lighting is integrated in the sides of the bathroom cabinets and measures 16 mm x 16 mm. Matching Down Light DL2.



Light shines both forward and inward on cabinets.

OPTIONAL



Down Light Linear LED

Chrome **DL2** £81
Chrome finish. White neutral sheen. IP44.
Dimmable with Linear LED Mirror Cabinet.
1 down light fits cabinet
40, 60, 80 and 100.



Extra Glass Shelves

For right size please see optional under
each bathroom cabinet.
Shelf brackets are included.

Can only be combined with Linear LED
Mirror Cabinet, Linear LED Mirrors and
Linead LED Top Light L102.

KENSINGTON

60, 80, 100 cm

Decorative framed mirror doors and drawers

Floor standing or Wall hung



New times need new elegance - as well as a splash of classical beauty. Our bathroom collection Kensington unites timeless beauty with a new era of design. The slightly bevelled sides, the beautiful well-designed frame mirrors, the care in every detail and the beautiful finish fills your bathroom with new, beautiful feelings.

Choose from a sleek rustic floor standing vanity with plinth or make use of the space in your bathroom with a beautiful wall-mounted vanity. Enjoy the choice between fashion colours white or dark grey or combine. Kensington surprises with plenty of space for both style and feel.

Kensington 80
Mirror Cabinet 54L-9
Decorative top for Mirror Cabinet 06-454-9
Down Light DL2
Vanity 489-9
Worktop with Basin 134W/800M
Tap 1940C
Storage 495V-9
WC 390W, Seat 347-4
Accessories Stockholm/Classic



Stone worktop with integrated basin. Available in 60, 80 and 100 cm. Choose between Italian Carrara Marble and Jura Limestone.



The basin is recessed in the stone work top which gives a 10 mm thin stone edge on the inside even though the stone worktops are 30 mm.



Kensington vanity units and storage units are available as floor standing with a plinth for a solid built impression. Alternatively as a wall hung option.



With different handles you can create your personal touch. Above is knob 3103C Ø30 mm.



The wall hung vanities feature a decorative bottom plate.



Wall hung vanity 60 with a Carrara Marble worktop.



A storage cabinet that gives more room and takes less space.



Adjustable wooden shelves in combination with drawers for optimal storage.



The basin is recessed in the Stone Worktop which gives a 10 mm thin stone edge on the inside even though the stone worktops are 30 mm.



Floor standing vanity 80 with linear led 80 Mirror Cabinet.



The plinth gives a solid built feel. The front is removable to ease cleaning under the vanity.

Decorative framed mirror doors and drawers. Choose between floor standing or wall hung. Available in white and dark grey.

Soft closing drawers and doors. The drawers are sturdy, fully expandable and fitted with anti-slip mats. Vanity bottom drawers are fitted with an adjustable bar to stop larger items from moving.

For your vanity you can choose between a full cover basin, stone worktop with integrated basin or a worktop with basin. See options below.

Complete the look with our range of taps and handles to add your own finished character to the bathroom furniture.

The furniture is delivered fully assembled.

Colour



White Dark Grey

Drawer Vanities in four ways:



1. Drawer Vanity with full cover basin
2. Drawer Vanity with stone worktop and integrated ceramic basin
3. Drawer Vanity with worktop, basin and tap mounted on the worktop
4. Drawer Vanity with worktop and basin with tap mounted on the basin

Full Cover Ceramic Basins in two shapes

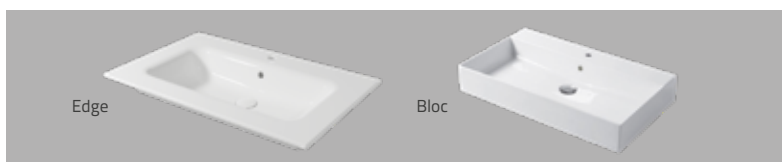

Stone Worktop with integrated ceramic basin



Basin for worktop, tap mounted on the work top



Basins for worktop, tap mounted on the basin



Worktops Stone 30 mm

Carrara Marble Jura Limestone

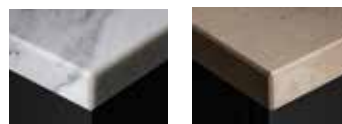

Our bathroom furniture has a guarantee. Read more on millerbathrooms.com

DETAILS KENSINGTON

Symbol shows that this feature is optional. **T**



A **Decorative Top** is available in Grey or White to put on top of our Linear Led Mirror Cabinets.



Top Drawer is equipped with a removable divider in solid oak. **Anti slip mats** in vanity units and storage cabinet drawers.



Wall hung furniture give a more modern look. Wooden bottom plate frames the furniture.



The plinth gives the furniture a solid built feeling. The front is removable for easy cleaning. Choose **floor standing** vanity with plinth or **wall hung** vanity.



A variety of **basins** available. Image shows Edge 80 in Gloss White with colour matched ceramic Waste.



Practical storage solutions for you to choose from.



Drawers have straight insides which allows you to take advantage of the entire surface.



Bathroom Cabinet 60, 80, 100, 120 are equipped with a centre divider in wood that gives a more flexible placement of the glass shelves.



Decorative **framed mirror doors** and fronts.



Integrated ceramic basin is one of the options for Kensington vanities.

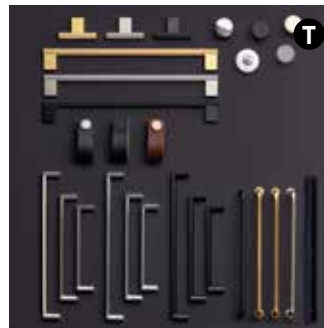

Handles and knobs. Choose between various finishes, shapes and sizes to create your personal touch. **Page 131.**

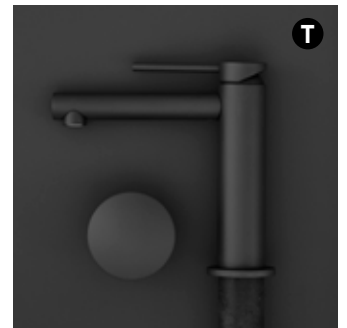

Taps. You can easily find a suitable and stylish favourite among our taps. **Page 129.**

KENSINGTON

Vanity units are fitted with mounting rails and brackets for easy adjustment and quick installation. Drawer fronts are adjustable in all directions. Fully extending drawers with soft close mechanism.

The drawers include an anti slip mat and removable wooden dividers in solid oak.

Lower drawers in vanities are equipped with a retaining bar. Vanity Units, basins, taps and handles are priced separately.

Choose between full cover basin, stone worktop with integrated basin or worktop with basin. All furniture is delivered fully assembled.

Read more about the Miller Way on www.millerbathrooms.co.uk

Colour

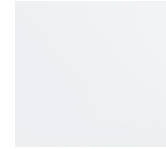

White -2









Dark Grey -9

For Vanity colour choose colour code and replace -X

60 / 80 / 100

Vanity with full cover ceramic basin

Size 60, 80, 100 - floorstanding or wall hung - price separately for vanity, basin and tap.

<p>60 floorstanding</p>  <p>Size vanity W610 x H802 x D458 mm Basin size see each model below</p> <p>Vanity floorstanding 2 drawers Choose colour 488-X £1056 Optional Handles page 131</p>	<p>80 floorstanding</p>  <p>Size vanity W810 x H802 x D458 mm Basin size see each model below</p> <p>Vanity floorstanding 2 drawers Choose colour 489-X £1076 Optional Handles page 131</p>	<p>100 floorstanding</p>  <p>Size vanity W1010 x H802 x D458 mm Basin size see each model below</p> <p>Vanity floorstanding 2 drawers Choose colour 498-X £1185 Optional Handles page 131</p>
<p>60 wall hung</p>  <p>Size vanity W610 x H644 x D458 mm Basin size see each model below</p> <p>Vanity wall hung 2 drawers Choose colour 1488-X £798 Optional Handles page 131</p>	<p>80 wall hung</p>  <p>Size vanity W810 x H644 x D458 mm Basin size see each model below</p> <p>Vanity wall hung 2 drawers Choose colour 1489-X £860 Optional Handles page 131</p>	<p>100 wall hung</p>  <p>Size vanity W1010 x H644 x D458 mm Basin size see each model below</p> <p>Vanity wall hung 2 drawers Choose colour 1498-X £968 Optional Handles page 131</p>
<p>Basins</p> <p>Gloss white ceramic basin for 60 vanity Edge 110-60X46-01 £366 Bloc 111-60X46-01 £438 For basins in other colours please see page 126</p>	<p>Gloss white ceramic basin for 80 vanity Edge 110-80X46-01 £469 Bloc 111-80X46-01 £541 For basins in other colours please see page 126</p>	<p>Gloss white ceramic basin for 100 vanity Edge 110-100X46-01 £572 Bloc 111-100X46-01 £675 For basins in other colours please see page 126</p>

Full cover Ceramic Basins



2 models and 4 colours

Colour coordinate our full cover Basins with floor standing or wall hung Toilets.

Colour coordinated ceramic Waste available as an option. Please see images of basins in all sizes on page 126.

Edge





Bloc



Measurements are for guidance only, exact measurement should be measured on the delivered basin.

Vanity with stone worktop and integrated ceramic basin

Size 60, 80, 100 - floorstanding or wall hung - price separately for vanity, worktop with integrated ceramic basin and tap

<p>60 floorstanding</p>  <p>Size vanity without worktop W610 x H802 x D458 mm</p>	<p>80 floorstanding</p>  <p>Size vanity without worktop W810 x H802 x D458 mm</p>	<p>100 floorstanding</p>  <p>Size vanity without worktop W1010 x H802 x D458 mm</p>		
<p>Vanity floorstanding 2 drawers Choose colour 488-XT £1056 Optional Handles page 131</p>	<p>Vanity floorstanding 2 drawers Choose colour 489-XT £1076 Optional Handles page 131</p>	<p>Vanity floorstanding 2 drawers Choose colour 498-XT £1185 Optional Handles page 131</p>		
<p>60 wall hung</p>  <p>Size vanity without worktop W610 x H644 x D458 mm</p>	<p>80 wall hung</p>  <p>Size vanity without worktop W810 x H644 x D458 mm</p>	<p>100 wall hung</p>  <p>Size vanity without worktop W1010 x H644 x D458 mm</p>		
<p>Vanity wall hung 2 drawers Choose colour 1488-XT £798 Optional Handles page 131</p>	<p>Vanity wall hung 2 drawers Choose colour 1489-XT £860 Optional Handles page 131</p>	<p>Vanity wall hung 2 drawers Choose colour 1498-XT £968 Optional Handles page 131</p>		
<p>Choose stone worktop with integrated ceramic basin</p> <p>Worktop for 60 vanity Marble 134W/600M £1750 Jura 134W/600J £1750 Price incl.integrated ceramic basin Size worktop W595 x D455 x H30 mm</p>			<p>Worktop for 80 vanity Marble 134W/800M £1853 Jura 134W/800J £1853 Price incl.integrated ceramic basin Size worktop W795 x D455 x H30 mm</p>	<p>Worktop for 100 vanity Marble 134W/1000M £1956 Jura 134W/1000J £1956 Price incl.integrated ceramic basin Size worktop W995 x D455 x H30 mm</p>
 <p>Total size work top W595 x D455 x H30 mm Ceramic W490 x D320 mm. Max depth bowl 160 mm</p>	 <p>Total size work top W795 x D455 x H30 mm Ceramic W490 x D320 mm. Max depth bowl 160 mm</p>	 <p>Total size work top W995 x D455 x H30 mm Ceramic W490 x D320 mm. Max depth bowl 160 mm</p>		

Genuine stone worktop 30 mm with integrated ceramic basin

Up to 6 weeks delivery









Carrara Marble



Limestone Jura

Vanity with work top and basin, tap mounted on the basin

Size 60, 80, 100 - floorstanding or wall hung - price separately for vanity, basin and tap.

<p>60 floorstanding</p>  <p>Size vanity W610 x H802 x D458 mm Basin size see each model below</p>	<p>80 floorstanding</p>  <p>Size vanity W810 x H802 x D458 mm Basin size see each model below</p>	<p>100 floorstanding</p>  <p>Size vanity W1010 x H802 x D458 mm Basin size see each model below</p>																		
<p>Vanity unit floorstanding 2 drawers Choose colour 488-XT £1056 Optional Handles page 131</p>	<p>Vanity unit floorstanding 2 drawers Choose colour 489-XT £1076 Optional Handles page 131</p>	<p>Vanity unit floorstanding 2 drawers Choose colour 498-XT £1185 Optional Handles page 131</p>																		
<p>60 wall hung</p>  <p>Size vanity W610 x H644 x D458 mm Basin size see each model below</p>	<p>80 wall hung</p>  <p>Size vanity W810 x H644 x D458 mm Basin size see each model below</p>	<p>100 wall hung</p>  <p>Size vanity W1010 x H644 x D458 mm Basin size see each model below</p>																		
<p>Vanity unit wall hung 2 drawers Choose colour 1488-XT £798 Optional Handles page 131</p>	<p>Vanity unit wall hung 2 drawers Choose colour 1489-XT £860 Optional Handles page 131</p>	<p>Vanity unit wall hung 2 drawers Choose colour 1498-XT £968 Optional Handles page 131</p>																		
<p>Worktop</p> <p>Worktop for 60 vanity</p> <table border="0"> <tr> <td>Marble</td> <td>600M</td> <td>£639</td> </tr> <tr> <td>Jura</td> <td>600J</td> <td>£639</td> </tr> </table> <p>Size worktop W595 x D455 mm For height see each work top</p>	Marble	600M	£639	Jura	600J	£639	<p>Worktop for 80 vanity</p> <table border="0"> <tr> <td>Marble</td> <td>800M</td> <td>£742</td> </tr> <tr> <td>Jura</td> <td>800J</td> <td>£742</td> </tr> </table> <p>Size worktop W795 x D455 mm For height see each work top</p>	Marble	800M	£742	Jura	800J	£742	<p>Worktop for 100 vanity</p> <table border="0"> <tr> <td>Marble</td> <td>1000M</td> <td>£850</td> </tr> <tr> <td>Jura</td> <td>1000J</td> <td>£850</td> </tr> </table> <p>Size worktop W995 x D455 mm For height see each work top</p>	Marble	1000M	£850	Jura	1000J	£850
Marble	600M	£639																		
Jura	600J	£639																		
Marble	800M	£742																		
Jura	800J	£742																		
Marble	1000M	£850																		
Jura	1000J	£850																		

Waste and tap hole position

The worktops are pre-cut with tap hole and waste holes as per diagram.

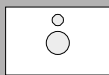

60, 80, 100

Stone worktop 30 mm

Up to 6 weeks delivery



Carrara Marble

Limestone 30 mm

Up to 6 weeks delivery



Jura

Ceramic basins in three shapes

116W1	£484
171W1	£308
173W1	£308

For more information on each basin please see page 126.

116W1



W500 x D495 x H180 mm

171W1



Ø460 x H130 mm

173W1



W550 x H130 x D450 mm

Vanity with work top and basin, column tap mounted on the worktop

Size 60, 80, 100 - floorstanding or wall hung - price separately for vanity, basin and tap.

<p>60 floorstanding</p>  <p>Size vanity W610 x H802 x D458 mm Basin size see each model below</p>	<p>80 floorstanding</p>  <p>Size vanity W810 x H802 x D458 mm Basin size see each model below</p>	<p>100 floorstanding</p>  <p>Size vanity W1010 x H802 x D458 mm Basin size see each model below</p>
<p>Vanity unit floorstanding 2 drawers Choose colour 488-XT £1056 Optional Handles page 131</p>	<p>Vanity unit floorstanding 2 drawers Choose colour 489-XT £1076 Optional Handles page 131</p>	<p>Vanity unit floorstanding 2 drawers Choose colour 498-XT £1185 Optional Handles page 131</p>
<p>60 wall hung</p>  <p>Size vanity W610 x H644 x D458 mm Basin size see each model below</p>	<p>80 wall hung</p>  <p>Size vanity W810 x H644 x D458 mm Basin size see each model below</p>	<p>100 wall hung</p>  <p>Size vanity W1010 x H644 x D458 mm Basin size see each model below</p>
<p>Vanity unit wall hung 2 drawers Choose colour 1488-XT £798 Optional Handles page 131</p>	<p>Vanity unit wall hung 2 drawers Choose colour 1489-XT £860 Optional Handles page 131</p>	<p>Vanity unit wall hung 2 drawers Choose colour 1498-XT £968 Optional Handles page 131</p>
<p>Worktop</p> <p>Worktop for 60 vanity Marble 600M-X £639 Jura 600J-X £639</p> <p>Size worktop W595 x D455 mm For height see each worktop</p>	<p>Worktop for 80 vanity Marble 800M-X £742 Jura 800J-X £742</p> <p>Size worktop W795 x D455 mm For height see each worktop</p>	<p>Worktop for 100 vanity Marble 1000M-X £850 Jura 1000J-X £850</p> <p>Size worktop W995 x D455 mm For height see each worktop</p>

NOTE -X, choose hole pattern, ex. 600M-V is a 60 cm Marble worktop with tap hole to the left of the basin
ex. 600J-H is a 60 cm Jura worktop with tap hole to the right of the basin

Waste and tap hole position

The tap is placed to the right or to the left of the basin on the worktop.

to the right **-H**



add a -H after the worktop code no. ie: 600M-H







The worktops are pre-cut with tap hole and waste holes as per diagram.

to the left **-V**



add a -H after the worktop code no. ie: 600M-H

Ceramic basins



<p>Basin for worktop, column tap mounted on the side of the basin</p> <p>130-R40-01 £350 Available in more colours - see page 126. 131-R40-01 £350 Available in more colours - see page 126. 133W £324 132W £324</p> <p>Only column taps are suitable for these washbasins: 1941C, 1941MP, 1941B.</p>	<p>130-R40-01</p>  <p>Ø400 x H170 mm Max. depth bowl 150 mm</p>	<p>131-R40-01</p>  <p>Ø400 x H165 mm Max. depth bowl 122 mm</p>	<p>133W</p>  <p>Ø390 x H150 mm Max. depth bowl 130 mm</p>	<p>132W</p>  <p>W390 x D390 x H130 mm Max. depth bowl 95 mm</p>
---	---	--	---	---

Measurements are for guidance only, exact measurement should be measured on the delivered basin.

KENSINGTON STORAGE recessed decorative framed doors and drawers

Fitted with mounting rails and brackets for easy adjustment and quick installation. Soft closing doors and drawers. V stands for left hand door and H stands for right hand door (see sketch). All furniture is delivered fully assembled.

Read more about the Miller Way on www.millerbathrooms.co.uk

<p>Tall Cabinet with 2 drawers floorstanding</p> <p>1 fixed and 2 adjustable glass shelves 2 drawers, bottom drawer with retaining bar</p>  <p>W420 x H1786 x D391 mm</p> <p>Left hand door Choose colour 492V-X £1370</p> <p>Right hand door Choose colour 492H-X £1370</p> <p>Optional Handles page 131</p>	<p>Tall Cabinet with door storage and 2 drawers floorstanding</p> <p>1 fixed and 2 adjustable glass shelves 2 drawers, bottom drawer with retaining bar</p>  <p>W420 x H1786 x D391 mm</p> <p>Left hand door Choose colour 495V-X £1597</p> <p>Right hand door Choose colour 495H-X £1597</p> <p>Optional Handles page 131</p>	<p>Storage Cabinet</p> <p>1 fixed and 2 adjustable glass shelves</p>  <p>W320 x H1138 x D265 mm</p> <p>Left hand door Choose colour 496V-X £536</p> <p>Right hand door Choose colour 496H-X £536</p> <p>Optional Handles page 131</p>
<p>Tall Cabinet with 2 drawers wall hung</p> <p>1 fixed and 2 adjustable glass shelves 2 drawers, bottom drawer with retaining bar</p>  <p>W420 x H1628 x D391 mm</p> <p>Left hand door Choose colour 1492V-X £1076</p> <p>Right hand door Choose colour 1492H-X £1076</p> <p>Optional Handles page 131</p>	<p>Tall Cabinet with door storage and 2 drawers wall hung</p> <p>1 fixed and 2 adjustable glass shelves 2 drawers, bottom drawer with retaining bar</p>  <p>W420 x H1628 x D391 mm</p> <p>Left hand door Choose colour 1495V-X £1370</p> <p>Right hand door Choose colour 1495H-X £1370</p> <p>Optional Handles page 131</p>	<p>OPTIONAL</p>  <p>Choose between a right or left hand door on your storage cabinet. See sketch above. V is for left hand door and H is right hand door in the code no.</p>  <p>Handles and knobs. Choose between various finishes, shapes and sizes to create your personal touch. See page 131.</p> <p>Colours</p>  <p>White -2 Dark Grey -9</p> <p>For Vanity colour choose colour code and replace -X</p>



NEW YORK

40, 60, 80, 100, 120 cm
Grain effect wood finishes
and smooth white finish



Sharp and minimalist elegance. Stylish, clean surfaces give a clear reflection of the modern man's quest for simple beauty and harmony. Just like the city with the same name, this collection is filled with endless choices. Vanity units are available in different widths. The careful details such as the soft closure, the thin basin, the practical storage, the beautiful finish - these all create a special feeling for your bathroom which you will want to retain forever.

New York 80
Basin Edge 80
Ambient Mirror 90
Tap 1940C
Accessories Bond



New York is now available in Light Oak. A durable material with a fantastic wood pattern that is light resistant.



Vanity 60 288-11 with Bloc Basin 60. Tap 1940C, Bond Accessories. Mirror Cabinet Linear Led 60.



Vanity 80 Dark Oak 289-12 with Worktop City Laminate 800-2. Ceramic Cylinder Basin with matching Ceramic Waste. Tap 1941C. Floor standing Toilet. Ambient Classic Mirror 90 with bevelled edge. Signature Collection Accessories.



Vanity 80 Dark Oak 289-12 with Edge Basin 80. Tap 1943BN, Miami Accessories. Ambient Classic Mirror 90 with bevelled edge. Tall Cabinet 293V-12.



Vanity 80 Dark Oak 289-12 with Edge Basin 80. Tap 1943BN, Miami Accessories. Ambient Classic Mirror 90.



Vanity 80 289-2 with Worktop City Laminate 800-2 and Basin Cylinder. Tap 1941C and Ambient Mirror.



Bloc Basin with matching ceramic Waste.



Edge Basin with matching ceramic Waste.



Grain effect wood finishes and smooth white finish. Soft closing drawers and doors. The drawers are sturdy, fully expandable and fitted with anti-slip mats. Vanity unit top drawers have compartments in solid natural oak that can easily be lifted out for cleaning.

The furniture is delivered fully assembled.

Vanity unit bottom drawers are fitted with an adjustable bar to stop larger items from moving. For your vanity you can choose between a full cover basin or a worktop with basin. See options below.

Complete the look with our range of taps and handles to add your own finished character to the bathroom furniture.

Colour

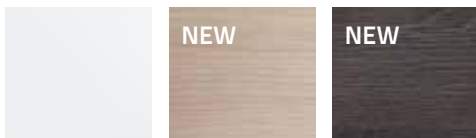

White smooth Light Oak* Dark Oak*

*A durable material with a fantastic wood pattern that is light resistant.

Drawer Vanity sizes 60 / 80 / 100 / 120



- Drawer Vanity in 3 ways:
1. Drawer Vanity with full cover basin
 2. Drawer Vanity with worktop, basin and tap mounted on the worktop
 3. Drawer Vanity with worktop and tap mounted on the basin

Door Vanity sizes 40



- Door Vanity in 2 ways:
1. 35 cm shallow vanity, W400 mm
 2. Door Vanity with worktop, W400 mm

Full Cover Ceramic Basins in two shapes

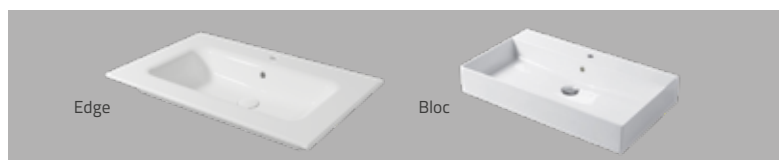

Stone Worktop and integrated ceramic basin



Several Basins for worktop, tap mounted on the work top



Basins for worktop, tap mounted on the basin



Worktops Stone 30 mm

Carrara Marble Jura Limestone

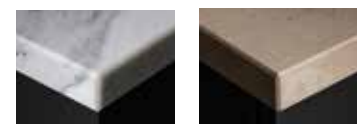

Wood Worktop City laminate 18 mm

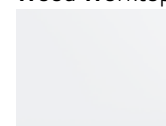

Matt White

DETAILS NEW YORK

Symbol shows that this feature is optional. **T**



Fully extendable, soft closing drawers. Tall drawers and lower drawer in the double vanity are equipped with an adjustable retaining bar that keeps bottles in place.



Top drawers are equipped with an adjustable divider in wood.



Anti slip mats in vanity units and storage cabinet drawers.



Drawers have straight insides which allows you to take advantage of the entire surface.



A variety of **basins** available. Image shows Edge 80 in Gloss White with colour matched ceramic Waste.



New Colour Dark Oak*



New Colour Light Oak*



Bathroom Cabinet 60, 80, 100, 120 are equipped with a centre divider in wood that gives a more flexible placement of the glass shelves.



Our bathroom furniture has a guarantee. Read more on millerbathrooms.com



Many door vanity combinations to choose from, with worktops or full cover basins.

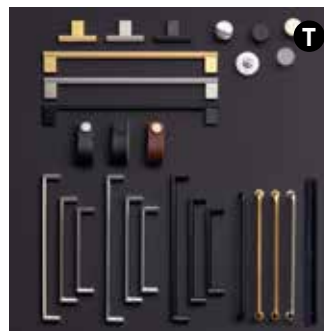

Handles and knobs. Choose between various finishes, shapes and sizes to create your personal touch. **Page 131.**

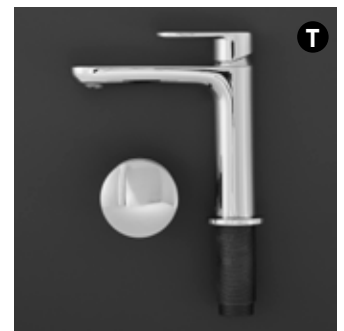

Taps. You can easily find a suitable and stylish favourite among our taps on **page 129.**

*A durable material with a fantastic wood pattern that is light resistant. Available as an option for Linear Led Mirror Cabinets and Storage Cabinets.

NEW YORK

Vanity units are fitted with mounting rails and brackets for easy adjustment and quick installation. Drawer fronts are adjustable in all directions. Fully extending drawers with soft close mechanism. The drawers include an anti slip mat and removable wooden dividers.

Vanity units, basins, taps and handles are priced separately. Double and high vanity units are equipped with a retaining bar.

Choose between full cover basin or worktop with basin. All furniture is delivered fully assembled.

Read more about the Miller Way on www.millerbathrooms.co.uk

Colour

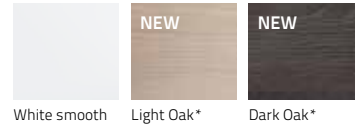





*A durable material with a fantastic wood pattern that is light resistant.

40 / 60 / 80 / 100 / 120

Vanity with full cover basin

1 tall drawer or 2 drawers - price separately for vanity, basin and tap

60 Double	80 Double	100 Double	120 Double
			
Vanity size W590 x H580 x D455 mm Basin size see each model below	Vanity size W790 x H580 x D455 mm Basin size see each model below	Vanity size W990 x H580 x D455 mm Basin size see each model below	Vanity size W1190 x H580 x D455 mm Basin size see each model below
Vanity Unit 2 drawers	Vanity Unit 2 drawers	Vanity Unit 2 drawers	Vanity Unit 4 drawers
White 288-2 £675	White 289-2 £721	White 298-2 £798	White 266-2 £1391
Light Oak 288-11 £795	Light Oak 289-11 £840	Light Oak 298-11 £915	Light Oak 266-11 £1600
Dark Oak 288-12 £795	Dark Oak 289-12 £840	Dark Oak 298-12 £915	Dark Oak 266-12 £1600
Optional	Optional	Optional	Optional
Handles page 131	Handles page 131	Handles page 131	Handles page 131
Basins			
<i>Gloss white ceramic basin for 60 vanity</i>	<i>Gloss white ceramic basin for 80 vanity</i>	<i>Gloss white ceramic basin for 100 vanity</i>	<i>Gloss white ceramic basin for 120 vanity</i>
Edge 110-60X46-01 £366	Edge 110-80X46-01 £469	Edge 110-100X46-01 £572	Edge 110-120X46-01 £778
Bloc 111-60X46-01 £438	Bloc 111-80X46-01 £541	Bloc 111-100X46-01 £675	Bloc 111-120X46-01 £881
For basins in other colours please see page 126	For basins in other colours please see page 126	For basins in other colours please see page 126	For basins in other colours please see page 126

Full cover Ceramic Basins



2 models and 4 colours
Colour match our full cover Basins with floor standing or wall hung Toilets.

Colour matched ceramic Waste available as an option. Please see images of basins in all sizes on page 126.

Edge



Bloc



Measurements are for guidance only, exact measurement should be measured on the delivered basin.

Vanity with doors

Size 40 or 60 cm - price separately for vanity, basin and tap

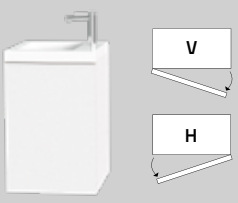
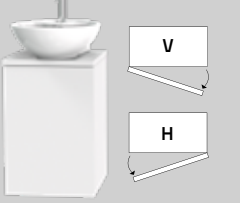
40 + 1 Door		40 + 1 Door + Worktop	
			
Total size W405 x H630 x D350 mm		Total size W405 x H755 x D350 mm Basin depth 415 mm	
<p><i>Left hand door</i></p> <p>White 284V-2 £401</p> <p>Light Oak 284V-11 £485</p> <p>Dark Oak 284V-12 £485</p> <p><i>Right hand door</i></p> <p>White 284H-2 £401</p> <p>Light Oak 284H-11 £485</p> <p>Dark Oak 284H-12 £485</p> <p><i>Basin</i></p> <p>White 165W1 £263</p> <p><i>Optional Handles</i> page 131</p>		<p><i>Left hand door</i></p> <p>White 284V-2T £401</p> <p>Light Oak 284V-11T £485</p> <p>Dark Oak 284V-12T £485</p> <p><i>Right hand door</i></p> <p>White 284H-2T £401</p> <p>Light Oak 284H-11T £485</p> <p>Dark Oak 284H-12T £485</p> <p><i>Basin</i></p> <p>White 174W1 £216</p> <p>White 135W £309</p> <p><i>Optional Handles</i> page 131</p>	

<p>Basin</p>  <p>165W1</p> <p>405 mm</p> <p>355 mm</p>	<p>174W1</p>  <p>415 mm</p> <p>Ø 400 mm</p>
	<p>135W</p>  <p>Ø 330 mm</p>

Stone Worktop for vanity 40

Stone Worktop 30 mm



Carrara Marble



Jura Limestone

For basin 174W1

30 mm worktop for 40 vanity

Marble **400M** £514

Jura **400J** £514

Measurement W408 x D358 mm



For basin 135W - choose -H/-V

30 mm worktop for 40 vanity

Marble **400M-X** £514

Jura **400J-X** £514

Measurement W408 x D358 mm



Wood Worktop for vanity 40

City Laminate 18 mm

18 mm worktop for 40 vanity

Choose colour **779-X** £129

Measurement W408 x D358 mm

Worktop delivered without waste hole.

Punching to be done by installer.



Classic White -2



Midnight Blue -3



Charcoal Black -4



Highland Green -6



Coffee Cream -7





Thunder Grey -9



Cotton Cream -10

Drawer Vanity with worktop, basin and tap mounted on the worktop

Size 60, 80, 100, 120 - price separately for vanity, basin and tap

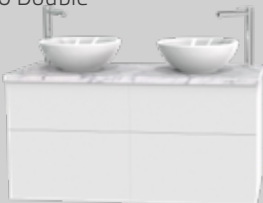
60 Double	80 Double	100 Double	120 Double
			
Size vanity W590 x H580 x D448 mm Size of basin see each model below	Size vanity W790 x H580 x D448 mm Size of basin see each model below	Size vanity W990 x H580 x D448 mm Size of basin see each model below	Size vanity W1180 x H580 x D448 mm Size of basin see each model below
Vanity Unit 2 drawers White 288-2T £675 Light Oak 288-11T £795 Dark Oak 288-12T £795 <i>Optional</i> Handles page 131	Vanity Unit 2 drawers White 289-2T £721 Light Oak 289-11T £840 Dark Oak 289-12T £840 <i>Optional</i> Handles page 131	Vanity Unit 2 drawers White 298-2T £798 Light Oak 298-11T £915 Dark Oak 298-12T £915 <i>Optional</i> Handles page 131	Vanity Unit 4 drawers White 266-2T £1391 Light Oak 266-11T £1600 Dark Oak 266-12T £1600 <i>Optional</i> Handles page 131
Choose Worktop <i>Worktop for 60 vanity</i> Marble 600M-X £639 Jura 600J-X £639 <i>White City Laminate 18 mm for 60 vanity</i> White 600-2 £160 Size worktop W600 x D455	<i>Worktop for 80 vanity</i> Marble 800M-X £742 Jura 800J-X £742 <i>White City Laminate 18 mm for 80 vanity</i> White 800-2 £201 Size worktop W800 x D455 mm	<i>Worktop for 100 vanity</i> Marble 1000M-X £850 Jura 1000J-X £850 <i>White City Laminate 18 mm for 100 vanity</i> White 1000-2 £242 Size worktop W1000 x D455 mm	<i>Worktop for 120 vanity</i> Marble 1200M-X £1060 Jura 1200J-X £1060 <i>White City Laminate 18 mm for 120 vanity</i> White 1200-2 £304 Size worktop W1200 x D455 mm

Waste and tap hole position

The worktops are pre-cut with tap hole and waste holes as per diagram.



to the right **-H**

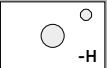

add **-H** after the worktop code no
example: 600M-H



to the left **-V**

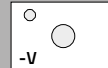

add **-V** after the worktop code no
example: 600M-V

120 left + right



example: 1200M-HV

120 to the left **-V**



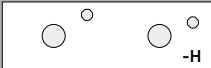

example: 1200M-V

120 to the right **-H**



example: 1200M-H

Basin for worktop, column tap mounted on the side of the basin

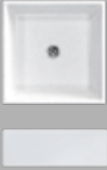
130-R40-01 £350 Available in more colours – see page 126	131-R40-01 £350 Available in more colours – see page 126	133W £324	132W £324
			
Ø400 x H170 mm Max. depth bowl 150 mm	Ø400 x H165 mm Max. depth bowl 122 mm	Ø390 x H150 mm Max. depth bowl 130 mm	W390 x D390 x H130 mm Max. depth bowl 95 mm

Only column taps are suitable for these washbasins: 1941C, 1941MP, 1941B.

Drawer Vanity with worktop, basin and tap mounted on the basin

Size 60, 80, 100, 120 - price separately for vanity, basin and tap

60 Double	80 Double	100 Double	120 Double
			
Size vanity W590 x H580 x D448 mm Size of basin see each model below	Size vanity W790 x H580 x D448 mm Size of basin see each model below	Size vanity W990 x H580 x D448 mm Size of basin see each model below	Size vanity W1180 x H580 x D448 mm Size of basin see each model below
<i>Vanity Unit 2 drawers</i> White 288-2T £675 Light Oak 288-11T £795 Dark Oak 288-12T £795 <i>Optional Handles</i> page 131	<i>Vanity Unit 2 drawers</i> White 289-2T £721 Light Oak 289-11T £840 Dark Oak 289-12T £840 <i>Optional Handles</i> page 131	<i>Vanity Unit 2 drawers</i> White 298-2T £798 Light Oak 298-11T £915 Dark Oak 298-12T £915 <i>Optional Handles</i> page 131	<i>Vanity Unit 4 drawers</i> White 266-2T £1391 Light Oak 266-11T £1600 Dark Oak 266-12T £1600 <i>Optional Handles</i> page 131
Choose Worktop <i>Worktop for 60 vanity</i> Marble 600M £639 Jura 600J £639 <i>White City Laminate 18 mm for 60 vanity</i> White 600-2 £160 Size worktop W600 x D455	<i>Worktop for 80 vanity</i> Marble 800M £742 Jura 800J £742 <i>White City Laminate 18 mm for 80 vanity</i> White 800-2 £201 Size worktop W800 x D455 mm	<i>Worktop for 100 vanity</i> Marble 1000M £850 Jura 1000J £850 <i>White City Laminate 18 mm for 100 vanity</i> White 1000-2 £242 Size worktop W1000 x D455 mm	<i>Worktop for 120 vanity</i> Marble 1200M £1060 Jura 1200J £1060 <i>White City Laminate 18 mm for 120 vanity</i> White 1200-2 £304 Size worktop W1200 x D455 mm

Waste and tap hole position

The worktops are pre-cut with tap hole and waste holes as per diagram.

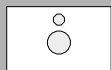

60, 80, 100



120, 160

Stone worktop 30 mm

Up to 6 weeks delivery



Carrara Marble

Limestone 30 mm

Up to 6 weeks delivery



Jura

City White laminate height 18 mm

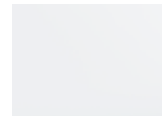

Matt White

Ceramic basins in three shapes

116W1 £484
171W1 £308
173W1 £308

For more information on each basin please see page 126.

116W1



W500 x D495 x H180 mm

171W1



Ø460 x H130 mm

173W1







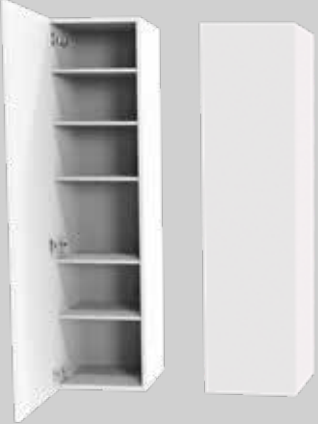

W550 x H130 x D450 mm

NEW YORK STORAGE

Fitted with mounting rails and brackets for easy adjustment and quick installation. Soft closing doors and drawers. V stands for left hand door and H stands for right hand door (see sketch). All furniture is delivered fully assembled.

Read more about the Miller Way on millerbathrooms.co.uk

<p>Tall Cabinet</p> <p>1 fixed and 4 adjustable glass shelves</p>  <p>W400 x H1690 x D380 mm</p> <p><i>Left hand door</i></p> <table border="0"> <tr><td>White</td><td>293V-2</td><td>£860</td></tr> <tr><td>Light Oak</td><td>293V-11</td><td>£1100</td></tr> <tr><td>Dark Oak</td><td>293V-12</td><td>£1100</td></tr> </table> <p><i>Right hand door</i></p> <table border="0"> <tr><td>White</td><td>293H-2</td><td>£860</td></tr> <tr><td>Light Oak</td><td>293H-11</td><td>£1100</td></tr> <tr><td>Dark Oak</td><td>293H-12</td><td>£1100</td></tr> </table> <p><i>Optional Handles</i> page 131</p>	White	293V-2	£860	Light Oak	293V-11	£1100	Dark Oak	293V-12	£1100	White	293H-2	£860	Light Oak	293H-11	£1100	Dark Oak	293H-12	£1100	<p>Tall Cabinet with door storage</p> <p>1 fixed and 4 adjustable glass shelves Door storage with 3 shelves</p>  <p>W400 x H1690 x D380 mm</p> <p><i>Left hand door</i></p> <table border="0"> <tr><td>White</td><td>294V-2</td><td>£1004</td></tr> <tr><td>Light Oak</td><td>294V-11</td><td>£1355</td></tr> <tr><td>Dark Oak</td><td>294V-12</td><td>£1355</td></tr> </table> <p><i>Right hand door</i></p> <table border="0"> <tr><td>White</td><td>294H-2</td><td>£1004</td></tr> <tr><td>Light Oak</td><td>294H-11</td><td>£1355</td></tr> <tr><td>Dark Oak</td><td>294H-12</td><td>£1355</td></tr> </table> <p><i>Optional Handles</i> page 131</p>	White	294V-2	£1004	Light Oak	294V-11	£1355	Dark Oak	294V-12	£1355	White	294H-2	£1004	Light Oak	294H-11	£1355	Dark Oak	294H-12	£1355	<p>Tall Cabinet with 2 drawers</p> <p>1 fixed and 3 adjustable glass shelves 2 drawers, bottom drawer with retaining bar</p>  <p>W400 x H1690 x D380 mm</p> <p><i>Left hand door</i></p> <table border="0"> <tr><td>White</td><td>291V-2</td><td>£1004</td></tr> <tr><td>Light Oak</td><td>291V-11</td><td>£1300</td></tr> <tr><td>Dark Oak</td><td>291V-12</td><td>£1300</td></tr> </table> <p><i>Right hand door</i></p> <table border="0"> <tr><td>White</td><td>291H-2</td><td>£1004</td></tr> <tr><td>Light Oak</td><td>291H-11</td><td>£1300</td></tr> <tr><td>Dark Oak</td><td>291H-12</td><td>£1300</td></tr> </table> <p><i>Optional Handles</i> page 131</p>	White	291V-2	£1004	Light Oak	291V-11	£1300	Dark Oak	291V-12	£1300	White	291H-2	£1004	Light Oak	291H-11	£1300	Dark Oak	291H-12	£1300
White	293V-2	£860																																																						
Light Oak	293V-11	£1100																																																						
Dark Oak	293V-12	£1100																																																						
White	293H-2	£860																																																						
Light Oak	293H-11	£1100																																																						
Dark Oak	293H-12	£1100																																																						
White	294V-2	£1004																																																						
Light Oak	294V-11	£1355																																																						
Dark Oak	294V-12	£1355																																																						
White	294H-2	£1004																																																						
Light Oak	294H-11	£1355																																																						
Dark Oak	294H-12	£1355																																																						
White	291V-2	£1004																																																						
Light Oak	291V-11	£1300																																																						
Dark Oak	291V-12	£1300																																																						
White	291H-2	£1004																																																						
Light Oak	291H-11	£1300																																																						
Dark Oak	291H-12	£1300																																																						
<p>Storage Cabinet</p> <p>1 fixed and 2 adjustable glass shelves</p>  <p>W400 x H1111 x D255 mm</p> <p><i>Left hand door</i></p> <table border="0"> <tr><td>White</td><td>296V-2</td><td>£587</td></tr> </table> <p><i>Right hand door</i></p> <table border="0"> <tr><td>White</td><td>296H-2</td><td>£587</td></tr> </table> <p><i>Optional Handles</i> page 131</p>	White	296V-2	£587	White	296H-2	£587	<p>Storage Cabinet with door storage</p> <p>1 fixed and 2 adjustable glass shelves Door storage with 3 shelves</p>  <p>W400 x H1111 x D255 mm</p> <p><i>Left hand door</i></p> <table border="0"> <tr><td>White</td><td>297V-2</td><td>£773</td></tr> </table> <p><i>Right hand door</i></p> <table border="0"> <tr><td>White</td><td>297H-2</td><td>£773</td></tr> </table> <p><i>Optional Handles</i> page 131</p>	White	297V-2	£773	White	297H-2	£773	<p>Mirror Cabinet with double sided mirror door</p> <p>1 fixed and 2 adjustable glass shelves, Frosted 20 mm edge at the opening on the outside Shown with optional top light L102</p>  <p>W400 x H1111 x D242 mm</p> <p><i>Left hand door</i></p> <table border="0"> <tr><td>White</td><td>96V-2</td><td>£613</td></tr> </table> <p><i>Right hand door</i></p> <table border="0"> <tr><td>White</td><td>96H-2</td><td>£613</td></tr> </table> <p><i>Optional Top Light</i> L102 £134</p> <p>Optional - This mirror cabinet is prepared for LED top light L102 £134</p> 	White	96V-2	£613	White	96H-2	£613																																				
White	296V-2	£587																																																						
White	296H-2	£587																																																						
White	297V-2	£773																																																						
White	297H-2	£773																																																						
White	96V-2	£613																																																						
White	96H-2	£613																																																						

OPTIONAL

Handles



Handles and knobs. Choose between various finishes, shapes and sizes to create your personal touch. See page 131.

Right or Left Hand Door?

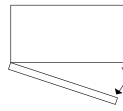

V = Left hand door

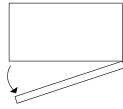

H = Right hand door

Choose between a right or left hand door on your storage cabinet. See sketch above. V is for left hand door and H is right hand door in the code no.

Colour

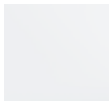

White smooth



Light Oak*

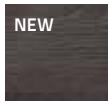

Dark Oak*

Tall Cabinets available in Light and Dark Oak.

*A durable material with a fantastic wood pattern that is light resistant.



Tall Cabinet 293V-12

LONDON

40, 60, 80, 100, 120 cm

Framed doors and drawer fronts



Classic beauty. Tasteful setting of drawers and fronts which enhances and deepens the impression of refined art. Inviting, clean lines with a beautiful finish that makes this collection obviously welcome in today's bathrooms. With the experience we have we know that all bathrooms are different - just like humans, so London is available in various sizes and in classic colours. The attention to the smallest detail adds to the comfort and knowledge that feeling nice, like beauty, is timeless.

London 80
Vanity 589-5
Basin Edge 80
Ambient Mirror 90
Tap 1940C



Vanity 584H-5T, Basin 174W1, Tap 1935C, Oak Worktop 79-5.



Vanity 589-5, Basin Bloc. Ambient Mirror 90. Tap 1943C, Accessories Bond.



Doors and drawers are 19 mm and gives a solid impression. Natural Oak doors are mostly made of solid Oak.



Beautiful frame mirror doors and drawers in timeless design. Choose a fullcover basin with high or low ceramic edge or Vanity with worktop and free standing basin.

Framed doors and drawer fronts are available in natural oak. Soft closing drawers and doors. The drawers are sturdy, fully expandable and fitted with anti-slip mats. Vanity unit top drawers have compartments in solid natural oak that can easily be lifted out for cleaning. Vanity unit bottom drawers are fitted with an adjustable bar to stop larger items from moving.

For your vanity you can choose between a full cover basin or a worktop with basin. See options below.

Complete the look with our range of taps and handles to add your own finished character to the bathroom furniture.

The furniture is delivered fully assembled.

Colour



Natural Oak

Drawer Vanity sizes 60 / 80 / 100 / 120



- 1. Drawer Vanity with full cover basin
- 2. Drawer Vanity with worktop, basin and tap mounted on the worktop
- 3. Drawer Vanity with worktop and tap mounted on the basin

Door Vanity sizes 40



- Door Vanity in 2 ways:
- 1. 35 cm shallow vanity, W400 mm
- 2. Door Vanity with worktop, W400 mm

Full Cover Ceramic Basins in two shapes

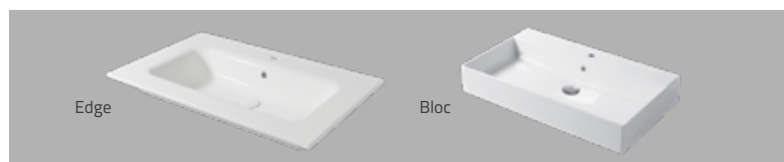

Stone Worktop and integrated ceramic basin



Several Basins for worktop, tap mounted on the work top



Basins for worktop, tap mounted on the basin



Worktops Stone 30 mm

Carrara Marble

Jura Limestone



Wood Worktop City laminate 18 mm

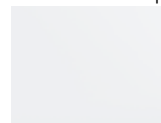

Matt White

DETAILS LONDON

Symbol shows that this feature is optional. **T**



Top drawers are equipped with an adjustable divider in wood.



Anti slip mats in vanity units and storage cabinet drawers.



Drawers have straight insides which allows you to take advantage of the entire surface.



A variety of **basins** available. Image shows Edge 80 in Gloss White with colour matched ceramic Waste.



Our bathroom furniture has a guarantee. Read more on millerbathrooms.com



Doors and drawers are 19 mm and gives a solid impression. Natural Oak is in solid oak.

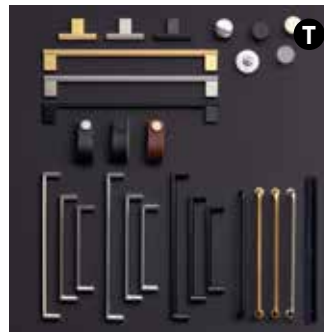

Handles and knobs. Choose between various finishes, shapes and sizes to create your personal touch. **Page 131.**



Taps. You can easily find a suitable and stylish favourite among our taps on **page 129.**

LONDON

Vanity units are fitted with mounting rails and brackets for easy adjustment and quick installation. Drawer fronts are adjustable in all directions. Fully extending drawers with soft close mechanism. The drawers include an anti slip mat and removable wooden dividers.

Vanity Units, basins, taps and handles are priced separately. Double and high vanity units are equipped with a retaining bar.

Choose between full cover basin or worktop with basin. All furniture is delivered fully assembled.

Read more about the Miller Way on www.millerbathrooms.co.uk

Colour







Natural Oak

40 / 60 / 80 / 100 / 120



Vanity with full cover basin

1 tall drawer or 2 drawers - price separately for vanity, basin and tap

60 Double	80 Double	100 Double	120 Double
			
Vanity size W590 x H580 x D455 mm Basin size see each model below	Vanity size W790 x H580 x D455 mm Basin size see each model below	Vanity size W990 x H580 x D455 mm Basin size see each model below	Vanity size W1190 x H580 x D455 mm Basin size see each model below
Vanity Unit 2 drawers Oak 588-5 £865 Optional Handles page 131	Vanity Unit 2 drawers Oak 589-5 £953 Optional Handles page 131	Vanity Unit 2 drawers Oak 598-5 £1004 Optional Handles page 131	Vanity Unit 4 drawers Oak 566-5 £1803 Optional Handles page 131
Basin Gloss white ceramic basin for 60 vanity unit Edge 110-60X46-01 £366 Bloc 111-60X46-01 £438 For basins in more colours please see page 126.	Gloss white ceramic basin for 80 vanity unit Edge 110-80X46-01 £469 Bloc 111-80X46-01 £541 For basins in more colours please see page 126.	Gloss white ceramic basin for 100 vanity unit Edge 110-100X46-01 £572 Bloc 111-100X46-01 £675 For basins in more colours please see page 126.	Gloss white ceramic basin for 120 vanity unit Edge 110-120X46-01 £778 Bloc 111-120X46-01 £881 - 120 vanity has 2 bowls For basins in more colours please see page 126.

Shallow Vanity with doors

Size 40 or 60 cm - price separately for vanity, basin and tap

40 + 1 Door	40 + 1 Door + Worktop
	
Total size W405 x H630 x D350 mm	Total size W405 x H755 x D350 mm Basin depth 415 mm
Left hand door Oak 584V-5 £541 Right hand door Oak 584H-5 £541 Basin White 165W1 £263 Optional Handles page 131	Left hand door Oak 584V-5T £541 Right hand door Oak 584H-5T £541 Basin White 174W1 £216 White 135W £309 Optional Handles page 131

Stone Worktop for vanity 40

Stone Worktop 30 mm



Carrara Marble Jura Limestone

For basin 174W1
30 mm worktop for 40 vanity
Marble **400M** £514
Jura **400J** £514
Measurement W408 x D358 mm

For basin 135W - choose -H/-V
30 mm worktop for 40 vanity
Marble **400M-X** £514
Jura **400J-X** £514
Measurement W408 x D358 mm



Wood Worktop for vanity 40

City Laminate 18 mm



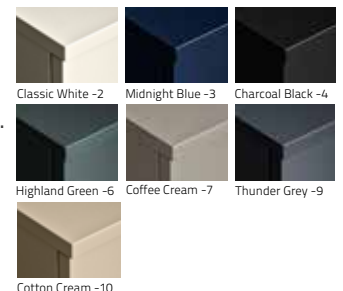

18 mm worktop for 40 vanity
Choose colour **779-X** £129
Measurement W408 x D358 mm
Worktop delivered without waste hole.
Punching to be done by installer.



Basin	165W1	174W1	135W
			
405 mm	415 mm	Ø 330 mm	

Drawer Vanity with worktop, basin and tap mounted on the worktop

Size 60, 80, 100, 120 - price separately for vanity, basin and tap

60 Double	80 Double	100 Double	120 Double
			
Size vanity W590 x H580 x D448 mm Size of basin see each model below	Size vanity W790 x H580 x D448 mm Size of basin see each model below	Size vanity W990 x H580 x D448 mm Size of basin see each model below	Size vanity W1180 x H580 x D448 mm Size of basin see each model below
Vanity Unit 2 drawers Oak 588-5T £865 <i>Optional Handles</i> page 131	Vanity Unit 2 drawers Oak 589-5T £953 <i>Optional Handles</i> page 131	Vanity Unit 2 drawers Oak 598-5T £1004 <i>Optional Handles</i> page 131	Vanity Unit 4 drawers Oak 566-5T £1803 <i>Optional Handles</i> page 131
Choose Worktop <i>Worktop for 60 vanity</i> Marble 600M-X £639 Jura 600J-X £639 White City Laminate 18 mm for 60 vanity White 600-2 £160 Size worktop W600 x D455	<i>Worktop for 80 vanity</i> Marble 800M-X £742 Jura 800J-X £742 White City Laminate 18 mm for 80 vanity White 800-2 £201 Size worktop W800 x D455 mm	<i>Worktop for 100 vanity</i> Marble 1000M-X £850 Jura 1000J-X £850 White City Laminate 18 mm for 100 vanity White 1000-2 £242 Size worktop W1000 x D455 mm	<i>Worktop for 120 vanity</i> Marble 1200M-X £1060 Jura 1200J-X £1060 White City Laminate 18 mm for 120 vanity White 1200-2 £304 Size worktop W1200 x D455 mm

Stone worktop 30 mm Limestone 30 mm City White laminate height 18 mm

Up to 6 weeks delivery Up to 6 weeks delivery



Carrara Marble



Jura

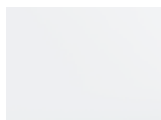

Matt White

Waste and tap hole position

The worktops are pre-cut with tap hole and waste holes as per diagram.

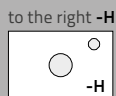

to the right **-H**
add **-H** after the worktop code no example: 600M-H

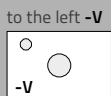

to the left **-V**
add **-V** after the worktop code no example: 600M-V

120 left + right

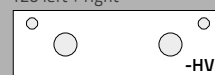

example: 1200M-HV

120 to the left -V



example: 1200M-V

120 to the right -H



example: 1200M-H

Basin for worktop, column tap mounted on the side of the basin

130-R40-01 £350 Available in more colours – see page 126
131-R40-01 £350 Available in more colours – see page 126
133W £324
132W £324

Only column taps are suitable for these washbasins: 1941C, 1941MP, 1941B.

130-R40-01



Ø400 x H170 mm
Max. depth bowl 150 mm

131-R40-01



Ø400 x H165 mm
Max. depth bowl 122 mm

133W



Ø390 x H150 mm
Max. depth bowl 130 mm



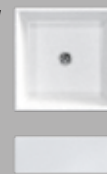

132W



W390 x D390 x H130 mm
Max. depth bowl 95 mm

Drawer Vanity with worktop, basin and tap mounted on the basin

Size 60, 80, 100, 120 - price separately for vanity, basin and tap

60 Double	80 Double	100 Double	120 Double
			
Size vanity W590 x H580 x D448 mm Size of basin see each model below	Size vanity W790 x H580 x D448 mm Size of basin see each model below	Size vanity W990 x H580 x D448 mm Size of basin see each model below	Size vanity W1180 x H580 x D448 mm Size of basin see each model below
Vanity Unit 2 drawers Oak 588-5T £865 Optional Handles page 131	Vanity Unit 2 drawers Oak 589-5T £953 Optional Handles page 131	Vanity Unit 2 drawers Oak 598-5T £1004 Optional Handles page 131	Vanity Unit 4 drawers Oak 566-5T £1803 Optional Handles page 131
Choose Worktop Worktop for 60 vanity Marble 600M £639 Jura 600J £639 White City Laminate 18 mm for 60 vanity White 600-2 £160 Size worktop W600 x D455	Worktop for 80 vanity Marble 800M £742 Jura 800J £742 White City Laminate 18 mm for 80 vanity White 800-2 £201 Size worktop W800 x D455 mm	Worktop for 100 vanity Marble 1000M £850 Jura 1000J £850 White City Laminate 18 mm for 100 vanity White 1000-2 £242 Size worktop W1000 x D455 mm	Worktop for 120 vanity Marble 1200M £1060 Jura 1200J £1060 White City Laminate 18 mm for 120 vanity White 1200-2 £304 Size worktop W1200 x D455 mm

Stone worktop 30 mm

Up to 6 weeks delivery



Carrara Marble

Limestone 30 mm

Up to 6 weeks delivery



Jura

City White laminate height 18 mm

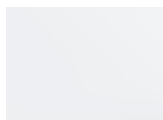

Matt White

Ceramic basins in three shapes	116W1	171W1	173W1	Waste and tap hole position
				
116W1 £484 171W1 £308 173W1 £308	W500 x D495 x H180 mm	Ø460 x H180 mm	W550 x H130 x D450 mm	The worktops are pre-cut with tap hole and waste holes as per diagram. 120
Measurements of each basin is available on millerbathrooms.co.uk				
Taps Choose between several models and colours see page 129.				

LONDON STORAGE OPTIONS

Handles



Handles and knobs. Choose between various finishes, shapes and sizes to create your personal touch. See page 131.

Right or Left Hand Door?

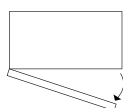

V = Left hand door

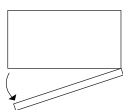

H = Right hand door

Colour



Natural Oak

Choose between a right or left hand door on your storage cabinet. See sketch above. V is for left hand door and H is right hand door in the code no.

LONDON STORAGE framed doors and drawers

Fitted with mounting rails and brackets for easy adjustment and quick installation. Soft closing doors and drawers. V stands for left hung door and H stands for right hung door (see sketch). All furniture is delivered fully assembled.

Read more about the Miller Way on www.millerbathrooms.co.uk

Tall Cabinet

1 fixed and 4 adjustable glass shelves



W400 x H1690 x D380 mm

Left hand door

Oak **593V-5** £1236

Right hand door

Oak **593H-5** £1236

Optional

Handles page 131

Tall Cabinet with door storage

1 fixed and 4 adjustable glass shelves
Door storage with 3 shelves



W400 x H1690 x D380 mm

Left hand door

Oak **594V-5** £1354

Right hand door

Oak **594H-5** £1354

Optional

Handles page 131

Storage Cabinet

1 fixed and 2 adjustable glass shelves



W400 x H1111 x D255 mm

Left hand door

Oak **596V-5** £736

Right hand door

Oak **596H-5** £736

Optional

Handles page 131

Storage Cabinet with door storage

1 fixed and 2 adjustable glass shelves
Door storage with 3 shelves



W400 x H1111 x D255 mm

Left hand door

Oak **597V-5** £979

Right hand door

Oak **597H-5** £979

Optional

Handles page 131

Mirror Cabinet with double sided mirror door

1 fixed and 2 adjustable glass shelves,
Frosted 20 mm edge at the opening on the outside
Shown with optional Top Light L102



W400 x H1111 x D242 mm

Left hung door

Oak **96V-5** £798

Right hung door

Oak **96H-5** £798

Optional

Top Light **L102** £134

Optional - This mirror cabinet is prepared for LED Top Light **L102** £134

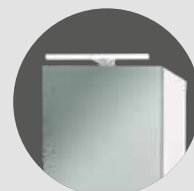

MIRROR CABINET LINEAR LED

Integrated dimmable light with touch sensor. Technically powerful LED light creates illuminated lines with better colour reproduction. Perfect for makeup. IP44 rated. Fitted with mounting rails and brackets for adjustable & quick installation. Soft closing double sided mirror doors. Choose left or right hand door for the 40 bathroom cabinet, see illustration below. All furniture is delivered fully assembled. Sides are in chosen colours, inside of the cabinets are white painted.

Read more about the Miller Way on www.millerbathrooms.co.uk

Colours

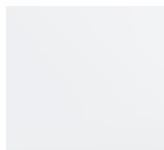

White



Natural Oak



Dark Grey

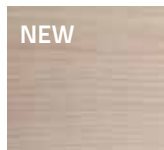

Light Oak*

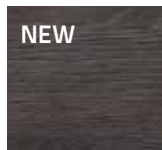

Dark Oak*

40 / 60 / 80 / 100

For Furniture Ranges:
Kensington, New York, London

40 linear led



W404 x H700 x D145 m

2 x glass shelves, IP44

Left hand door

White	52VL-2	£644
Oak	52VL-5	£809
Light Oak*	52VL-11	£809
Dark Oak*	52VL-12	£809

Right hand door

White	52HL-2	£644
Oak	52HL-5	£809
Light Oak	52HL-11	£809
Dark Oak	52HL-12	£809

Optional

Down Light	DL2	£81
2 extra glass shelves	54-190	£22

60 linear led



W590 x H700 x D145 mm

4 x glass shelves, centre wood divider, IP44

White	53L-2	£845
Oak	53L-5	£1015
Dark Grey	53L-9	£917
Light Oak*	53L-11	£1015
Dark Oak*	53L-12	£1015

Optional

Down Light	DL2	£81
2 extra glass shelves	53-190	£20

Optional Kensington furniture

Decorative top white	06-453-2	£36
Decorative top dark Grey	06-453-9	£36

80 linear led



W790 x H700 x D145 mm

4 x glass shelves, centre wood divider, IP44

White	54L-2	£948
Oak	54L-5	£1097
Dark Grey	54L-9	£1045
Light Oak*	54L-11	£1097
Dark Oak*	54L-12	£1097

Optional

Down Light	DL2	£81
2 extra glass shelves	54-190	£22

Optional Kensington furniture

Decorative top white	06-454-2	£41
Decorative top dark Grey	06-454-9	£41

100 linear led

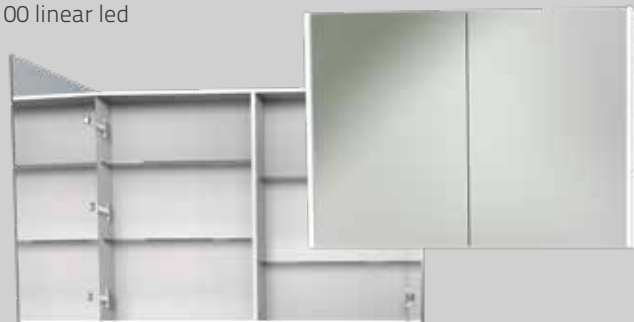

W990 x H700 x D145 mm

4 x glass shelves, centre wood divider, IP44

White	55L-2	£968
Oak	55L-5	£1154
Dark Grey	55L-9	£1102
Light Oak*	55L-11	£1154
Dark Oak*	55L-12	£1154

Optional

Down Light	DL2	£81
2 extra glass shelves	55-190	£24

Optional Kensington furniture

Decorative top white	06-455-2	£46
Decorative top dark Grey	06-455-9	£46

DETAILS



Centre divider in wood for stability and a more flexible placement of the shelves.



Light shines both forward and inward on cabinets.



Control the brightness with a touch sensor. Our new Bathroom Cabinet memorises the latest desired brightness when switched on and off.



A BRIGHTER FUTURE STARTS IN YOUR BATHROOM

Linear LED is energy saving yet very powerful. The vertical lights reduce shadow casting and gives you the perfect mirror reflection.

The built in touch sensor enables you to control the amount of light you want – and thanks to the built in memory the Linear LED remembers your preference until next time it's turned on.

Functional, practical and beautiful – the thin LED light bars shine both forward and inward on the cabinets, making sure you have a bright time in the bathroom.

The lighting is integrated in the sides of the bathroom cabinets and measures 16 mm x 16 mm. Matching Down Light DL2.

OPTIONAL



Down Light Linear Led

Size W350 x H10 x D24 mm



Extra glass shelves



Decorative Top

Chrome **DL2** £81
 Chrome finish. White neutral sheen. IP44. Dimmable with Linear LED Mirror Cabinet.

Can only be combined with Linear LED Mirror Cabinet, Linear LED Mirrors and Linead LED Top Light L102.

For right size please see optional under each bathroom cabinet. Shelf brackets are included.

For our Bathroom Collection Kensington we offer a Decorative Top in wood to match the vanities.

These are only available for Mirror Cabinets 60, 80 and 100 cm. Same size as the Kensington vanities. In Colours White and Dark Grey.

MIRROR CABINET with thin wooden frame

You choose if you want Top and Down Light to your Mirror Cabinet. There are two different models of Top and Down lights. Product images below are shown with Top Light L102. Price separately for Mirror Cabinet and Top/Down Light.

Fitted with mounting rails and brackets for adjustable & quick installation. Soft closing double sided mirror doors. Choose left or right hung door for the 40 bathroom cabinet, see illustration below. All furniture is delivered fully assembled.

Read more about the Miller Way on www.millerbathrooms.co.uk

Colours



White

Natural Oak

Dark Grey

40 / 60 / 80 / 100

For Furniture Ranges:
Kensington, New York, London

40 Mirror Cabinet



W404 x H700 x D145 mm

2 x glass shelves

Left hand door

White **52V-2G** £433

Oak **52V-5G** £541

Right hand door

White **52H-2G** £433

Oak **52H-5G** £541

Optional

Top Light **L102** £134

Down Light **DL2** £81

2 extra glass shelves **54-190** £22

60 Mirror Cabinet



W590 x H700 x D145 mm

4 x glass shelves, centre divider in wood

White **53-2G** £597

Oak **53-5G** £767

Dark Grey **53-9G** £597

Optional

Top Light **L102** £134

Down Light **DL2** £81

2 extra glass shelves **53-190** £20

80 Mirror Cabinet



W790 x H700 x D145 mm

4 x glass shelves, centre divider in wood

White **54-2G** £695

Oak **54-5G** £850

Dark Grey **54-9G** £695

Optional

Top Light **L102** £134

Down Light **DL2** £81

2 extra glass shelves **54-190** £22

100 Mirror Cabinet

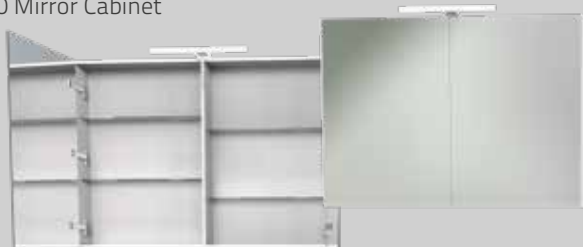

W990 x H700 x D145 mm

4 x glass shelves, centre divider in wood

1 extra hinge for stability

White **55-2G** £747

Oak **55-5G** £927

Dark Grey **55-9G** £747

Optional

Top Light **L102** £134

Down Light **DL2** £81

2 extra glass shelves **55-190** £24

120 Mirror Cabinet



W1180 x H700 x D145 mm
Choose 2 top/down lights

8 x glass shelves, 2 x 60 cabinets

Double centre divider in wood

White **56-2G** £1205

Oak **56-5G** £1591

Optional

Top Light **L102** £134

Down Light **DL2** £81

2 extra glass shelves **53-190** £20

MIRROR CABINET with thin wooden frame

DETAILS



Dimmer via the "DIM" sensor located at the bottom / end of the right light profile. Press and hold your finger against the sensor to increase / decrease the amount of light and release the sensor when you have reached desired amount of light. The cabinet will then remember the last set brightness when you turn on the cabinet next time.

Thin wooden edge along the sides of the cabinets. Mirror Cabinet 120 is shown above with Linear LED Top and Down Light, code no. L102 and DL2.

OPTIONAL MIRROR CABINET



Top Light Linear Led



Down Light Linear Led

Size W350 x H10 x D24 mm



Extra glass shelves

Chrome **L102** £134
White neutral sheen. IP44.
Dimmable.
1 top light fits 40, 60, 80 and 100.
Choose 2 top lights for 120.

Chrome **DL2** £81
Chrome finish. White neutral sheen.
IP44. Dimmable with Top Light L102.

Can only be combined with Linear LED Mirror Cabinet, Linear LED Mirrors and Linear LED Top Light L102.

For right size please see optional under each bathroom cabinet.
Shelf brackets are included.

MIRROR LINEAR LED

40 / 60 / 80 / 100

Integrated dimmable light with touch sensor. Technically powerful LED light creates illuminated lines with better colour reproduction. Perfect for makeup. IP44 rated. Down Light is available as an option for Linear Led Mirror. Fitted with mounting rails and brackets for adjustable & quick installation. All furniture is delivered fully assembled.

Read more about the Miller Way on www.millerbathrooms.co.uk



40 Linear LED Mirror

Chrome **59L** £458

Optional
Down Light **DL2** £81

60 Linear LED Mirror

Chrome **60L** £510

Optional
Down Light **DL2** £81

80 Linear LED Mirror

Chrome **61L** £561

Optional
Down Light **DL2** £81

100 Linear LED Mirror

Chrome **62L** £613

Optional
Down Light **DL2** £81

DETAILS



White neutral light, Led color 4000K, IP44.



Control the brightness with a touch sensor. Our Linear LED Mirror memorises the latest desired brightness when switched on and off.

OPTIONAL



Chrome **DL2** £81

Chrome finish. White neutral sheen. IP44. Dimmable with Top Light L102.

Can only be combined with Linear LED Mirror Cabinet, Linear LED Mirrors and Linear LED Top Light L102.

PLAIN MIRROR GLASS

40 / 60 / 80

4 mm mirror glass. Grade polished edge. Suspension bracket for easy mounting and floating effect. Choose with or without dimmable LED Top Light.

Read more about the Miller Way on www.millerbathrooms.co.uk



Plain Mirror Glass

		Width x Height x Depth mm	
Mirror 40	59-G	400 x 700 x 10	£51
Mirror 60	60-G	590 x 700 x 10	£72
Mirror 80	61-G	790 x 700 x 10	£93

Optional

LED Top Light	L102	L355 x D133, light .16 x 16	£134
---------------	------	-----------------------------	------

We recommend 2 x L102 for 120 Mirror 63-G Mirror.

ROUND MIRROR GLASS

70

4 mm mirror glass. Grade polished edge. Suspension bracket for easy mounting and floating effect. Choose with or without dimmable LED Top Light.

Read more about the Miller Way on www.millerbathrooms.co.uk



Round Mirror Glass

		Diameter x Depth mm	
Round Mirror 70	R70-G	Ø70 x 10	£82

Optional

LED Top Light	L102	L355 x D133, light .16 x 16	£134
---------------	------	-----------------------------	------

OPTIONAL



LED Top Light L102:

Control the brightness with a touch sensor. Our LED Top Light memorises the latest desired brightness when switched on and off. White neutral light, Led color 4000K, IP44. Easily mounted directly on the mirror glass. (The driver is built in and connects directly to 230V.)

AMBIENT LED MIRRORS

Oval 40x80 / 50x100 cm

Round 70 cm

Round 90 cm

Dimmable LED Mirrors with indirect light.

Controlled with touch-sensor.

Choose with or without bevelled edge

for a modern or classic look.

Demister pad.



Ambient 70 LED Mirror
Vanity City 60 Cotton Cream
Basin Edge 60 Cotton Cream
Tap 1940C
Wall Hung Toilet Cotton Cream
Accessories Miami



Dimmable
LED Lighting



Touch-sensor



Ambient 70

Modern look with flush edge

161-R70-L
Round Ø70 cm

£499



Ambient 90

Modern look with flush edge

161-R90-L
Round Ø90 cm

£599



Ambient Oval

Modern look with flush edge

161-40x80-L 40x80 cm
161-50x100-L 50x100 cm

£499

£549



Ambient 70 Classic

Classic look with 15mm bevelled edge

161-R70-BL
Round Ø70 cm

£599



Ambient 90 Classic

Classic look with 15mm bevelled edge

161-R90-BL
Round Ø90 cm

£699



Ambient Oval Classic

Classic look with 15mm bevelled edge

161-40x80-BL 40x80 cm
161-50x100-BL 50x100 cm

£599

£649

Ambient LED Mirrors

- Connects to on/off switch or solid current
- Stepless adjustment from 3000K - 6000K
- Button lights up dimly when mirror is off
- Built-in dimmer
- Demister pad
- IP44

The same button controls:

- On / off
- Cold / warm light
- Brightness

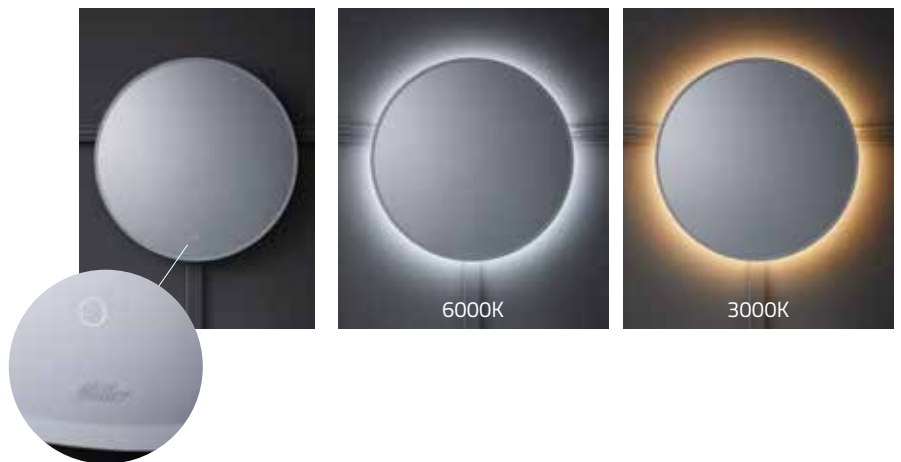

Detail: Touch-sensor and 15mm bevelled edge

CLASSIC

Ceramic basins in 2 different designs

4 different widths

Matching floor standing or wall hung Toilet



Our timeless ceramic collection has been expanded and we have chosen to call this range, Classic. Basins with pedestals are now available in two designs, Classic Square and Classic Arch.

Basin Set Classic Square large
330W-322W-1



Left to right: Floor Standing Toilet 388W-389W-C + Seat 347-4, Spare Roll Holder 5659CH, Toilet Roll Holder 5658CH, Basin Square with Pedestal 330W-321W-1, Mirror 643C, Basin Arch with Pedestal 332W-382W-1, Mirror 641C, Toilet Brush Set 5638C, Wall Hung Toilet 390W + Seat 347-2



Classic Square



Classic Arch

CLASSIC CERAMIC

The series is crafted by hand in England, giving the products a higher density, meaning they are more impact resistant. The ceramic itself has a glossier, deeper and finer, almost glass-like surface.

Classic Arch basins have overflow holes in the shape of three lines. **Classic Square** basins have overflow holes in the shape of three small circles.

Read more about the Miller Way on www.millerbathrooms.co.uk

Ceramic Basins, Pedestals and Toilets



Basin set Classic Arch small
Including pedestal
White **331W-381W-1** £875

Classic Arch basins can be wall hung.

Classic Arch small basin
Basin without pedestal
White **381W-1** £510

Basin set Classic Arch large
Including pedestal
White **332W-382W-1** £985

Classic Arch large basin
Basin without pedestal
White **382W-1** £625



Basin set Classic Square small
Including pedestal
White **330W-321W-1** £945

Classic Square basins can not be wall hung.

Basin set Classic Square large
Including pedestal
White **330W-322W-1** £1045

Floor Standing Toilet Classic
Including cistern
White **388W-389W-C** £1299
Seat
White **347-2** £295
Black Oak **347-4** £595

Wall Hung Toilet Classic
Excl. tank and seat. (Suitable for built in tank like Geberit Duofix.)
White **390W** £695
Seat
White **347-2** £295
Black Oak **347-4** £595



Left hand door
White **353V-2** £700
Right hand door
White **353H-2** £700

Left hand door
White **354V-2** £700
Right hand door
White **354H-2** £700





With or without wooden back plate, IP23.
Chrome finished with frosted white globe Ø150 mm. Polished Nickel.
With white back plate **301C-2** £225
Without back plate **301C** £199

Mirror with arched wooden frame and bevelled mirror glass. Fixed shelf with rail in chrome finish.
White **360C-2** £425

Cabinets - Arched frame with bevelled mirror glass alternatively panelled door in wood. 3 adjustable glass shelves. Bathroom cabinets are fitted with mounting rails and brackets for adjustable and quick installation.

Storage

Storage cabinets are available with plinth and adjustable feet or wall hung. Choose glass or wood panelled door. Storage cabinets are fitted with mounting rails and brackets for adjustable and quick installation. 1 fixed and 2 adjustable wood shelves. Wooden shelves have a decorative rounded front edge.

Storage cabinet floorstanding	Storage cabinet wall hung	Display cabinet floorstanding	Display cabinet wall hung
			
W439 x H1155 x D350 mm	W439 x H1125 x D350 mm	W439 x H1155 x D350 mm	W439 x H1125 x D350 mm
1 Panel Door Left hand door White 394V-2 £920 Right hand door White 394H-2 £920	1 Panel Door Left hand door White 1394V-2 £785 Right hand door White 1394H-2 £785	1 glass door with wood frame, tempered clear glass with bevelled edge Left hand door White 395V-2 £920 Right hand door White 395H-2 £920	1 glass door with wood frame, tempered clear glass with bevelled edge Left hand door White 1395V-2 £785 Right hand door White 1395H-2 £785



The floor standing toilet - now with an improved construction. Shown with Seat 347-2 in white acrylic. Soft close lid and quick release function.



Floor standing Toilet shown with Seat 347-4 in black stained solid oak. Soft close lid with decorative chrome fittings.



Classic tap

Delivered with pop up waste.
Chrome **19370C** £295

Basins are shown with tap 19370C in Chrome and classic style. Handles with ceramic details that read "hot" & "cold". Waste is included.



CERAMIC

All Edge and Bloc basins can be delivered in 4 colours. Glazed overflow holes. Matching waste cover in ceramic is optional. Can be ordered without tap hole with longer delivery time.























Soft close



Anti bacterial glaze

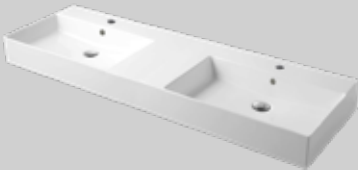

Easy to clean

<p>Edge 60 </p>  <p>110-60X46-01 Gloss white ceramic -01 £366 110-60X46-X Coloured ceramic -51, -54, -58 £479 W610 x H13 x D460 mm, max. depth bowl 120 mm</p>	<p>Edge 80 </p>  <p>110-80X46-01 Gloss white ceramic -01 £469 110-80X46-X Coloured ceramic -51, -54, -58 £613 W810 x H13 x D460 mm, max. depth bowl 120 mm</p>	<p>Edge 100 </p>  <p>110-100X46-01 Gloss white ceramic -01 £572 110-100X46-X Coloured ceramic -51, -54, -58 £778 W1010 x H13 x D460 mm, max. depth bowl 120 mm</p>
<p>Edge 120 </p>  <p>110-120X46-01 Gloss white ceramic -01 £778 110-120X46-X Coloured ceramic -51, -54, -58 £1025 W1210 x H15 x D460 mm, max. depth bowl 122 mm</p>	<p>Edge 160 </p>  <p>110-160X46-01 Gloss white ceramic -01 £1293 110-160X46-X Coloured ceramic -51, -54, -58 £1808 W1610 x H15 x D460 mm, max. depth bowl 122 mm</p>	<p>Bloc 60 </p>  <p>111-60X46-01 Gloss white ceramic -01 £438 111-60X46-X Coloured ceramic -51, -54, -58 £592 W604 x H125 x D462 mm, max. depth bowl 120 mm</p>
<p>Bloc 80 </p>  <p>111-80X46-01 Gloss white ceramic -01 £541 111-80X46-X Coloured ceramic -51, -54, -58 £747 W804 x H125 x D462 mm, max. depth bowl 102 mm</p>	<p>Bloc 100 </p>  <p>111-100X46-01 Gloss white ceramic -01 £675 111-100X46-X Coloured ceramic -51, -54, -58 £922 W1004 x H125 x D462 mm, max. depth bowl 102 mm</p>	<p>Bloc 120 </p>  <p>111-120X46-01 Gloss white ceramic -01 £881 111-120X46-X Coloured ceramic -51, -54, -58 £1231 W1204 x H125 x D462 mm, max. depth bowl 102 mm</p>
<p>Bloc 160 </p>  <p>111-160X46-01 Gloss white ceramic -01 £1396 111-160X46-X Coloured ceramic -51, -54, -58 £1942 W1610 x H125 x D462 mm, max. depth bowl 102 mm</p>	<p>Edge Bowl</p>  <p><i>Basin 130-R40 is mounted on a worktop. It is only suitable with tap 1941 which is delivered with a fixed waste.</i></p> <p>130-R40-01 Gloss white ceramic -01 £350 130-R40-X Coloured ceramic -51, -54, -58 £479 Ø420 x H170 mm, max. depth bowl 150 mm</p>	<p>Edge Cylinder</p>  <p><i>Basin 131-R40 is mounted on a worktop. It is only suitable with tap 1941 which is delivered with a fixed waste.</i></p> <p>131-R40-01 Gloss white ceramic -01 £350 131-R40-X Coloured ceramic -51, -54, -58 £479 Ø400 x H165 mm, max. depth bowl 122 mm</p>

Bloc basins can be wall hung - For wall hanging of basins, we recommend using suitable brackets as support - not included. The basins are manufactured in genuine ceramic and therefore have a certain measurement tolerance. All measurements are for guidance only. Exact dimensions should be measured on each product you purchase before fitting. Technical drawings are available on www.millerbathrooms.co.uk.

Optional

No Taphole option

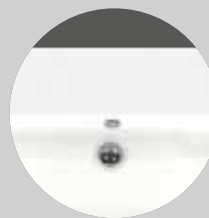

Matching ceramic Waste

- 110-190-01 Ceramic Waste - Gloss white ceramic £118
- 110-190-X Ceramic Waste - Coloured ceramic £139

No taphole solutions on all fullcover basins possible with extended lead time on request. Please contact nearest retailer for full details

Colour codes Edge, Bloc and Toilets



Coffee Cream -54

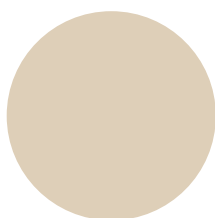

Cotton Cream -58

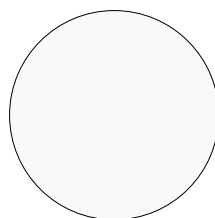

Matt White -51

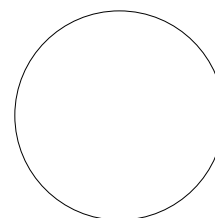

Gloss White -01

Wall Hung Toilet incl. Seat



Rimless flush. Soft close, quick release plastic seat. Colour matched seat is included in the price.

- 190-WCSET-01 Gloss white ceramic -01 £664
- 190-WCSET-X Coloured ceramic/seat -51, -54, -58 £922

W375 x D500 mm



Quick release

Floor Standing Toilet incl. Seat



Rimless flush. Soft close, quick release plastic seat. Colour matched seat is included in the price.

- 191-WCSET-01 Gloss white ceramic -01 £664
- 191-WCSET-X Coloured ceramic/seat -51, -54, -58 £922

W375 x D500 x H405 mm



Quick release



Coffee Cream -54



Cotton Cream -58





















Matt White -51



Gloss White -01

CERAMIC

The basins are manufactured in genuine ceramic and therefore have a certain measurement tolerance. All measurements are for guidance only. Exact dimensions should be measured on each product you purchase before fitting. Technical drawings are available on www.millerbathrooms.co.uk.

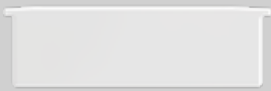
<p>Tap placed on the worktop, or inside wall</p>   <p>135W Ø330 x H125 mm, max. depth bowl 90 mm</p> <p>£309</p>		<p>Tap placed on the worktop, or inside wall</p>   <p>133W Ø395 x H150 mm, max. depth bowl 130 mm</p> <p>£324</p>	
<p>Tap placed on the worktop, or inside wall</p>   <p>151W Ø400/195 x H135 mm</p> <p>£340</p>		<p>Tap placed on the worktop, or inside wall</p>   <p>150W Ø400/195 x H135 mm</p> <p>£340</p>	
<p>174W1</p>   <p>174W1 Ø400x H150 x D415 mm</p> <p>£216</p>	<p>116W1</p>   <p>116W1 W500 x H180 x D495 mm</p> <p>£484</p>	<p>W405 x D355 mm</p>   <p>165W1 W405 x H50 x D355 mm</p> <p>£263</p>	
<p>171W1</p>   <p>171W1 Ø460 x H130 mm</p> <p>£308</p>	<p>173W1</p>   <p>173W1 W550 x H130 x D450 mm</p> <p>£308</p>	<p>P134W</p>   <p>P134W undermount basin £376 Note Exact dimensions are measured on delivered product before making work top cut outs. W490 x D320 mm. Max depth bowl 160 mm</p>	

TAPS AND WASTE

Taps are delivered without waste except tap: 1941C, 1941MP, 1941B which are delivered with a free flow waste - always open. 1937C, 1940C, 1940MP, 1940B, 1942C, 1943C, 1943B, 1943BN, are delivered with a pop-up waste. Technical drawings are available on millerbathrooms.co.uk. All taps are high pressure.

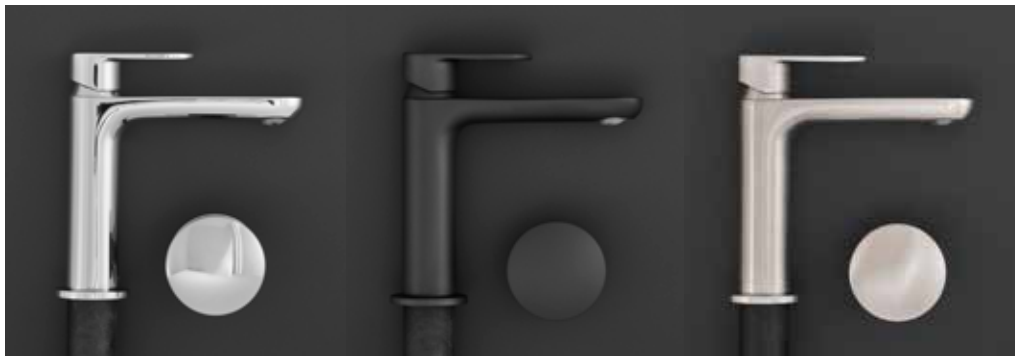

1943C
Chrome
"Click-clack" waste included
Close/open by pressing the lid

£295

1943B
Matt Black
"Click-clack" waste included
Close/open by pressing the lid

£395

1943BN
Stainless Steel finish
"Click-clack" waste included
Close/open by pressing the lid

£395

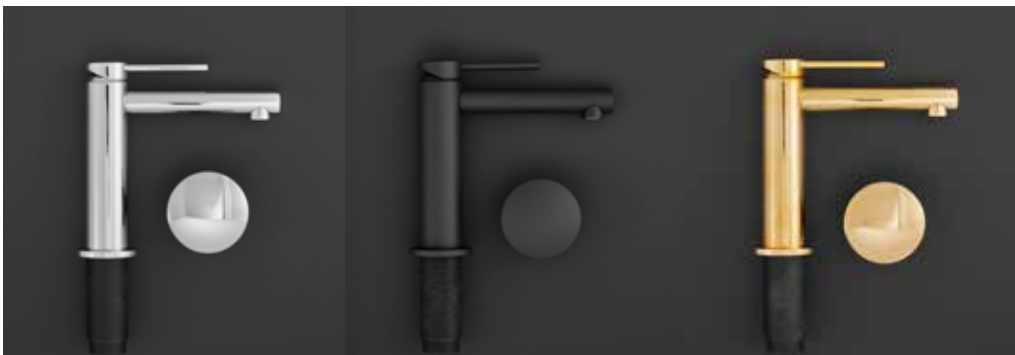
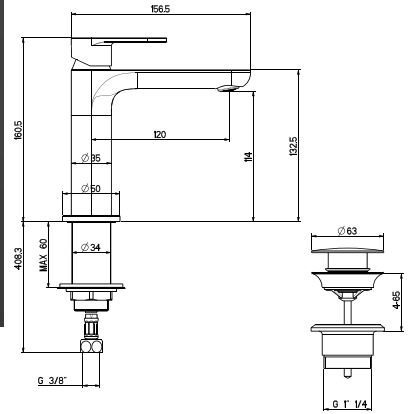

1940C
Chrome
"Click-clack" waste included
Close/open by pressing the lid

£365

1940B
Matt Black
"Click-clack" waste included
Close/open by pressing the lid

£495

1940MP
Polished untreated Brass
"Click-clack" waste included
Close/open by pressing the lid

£495

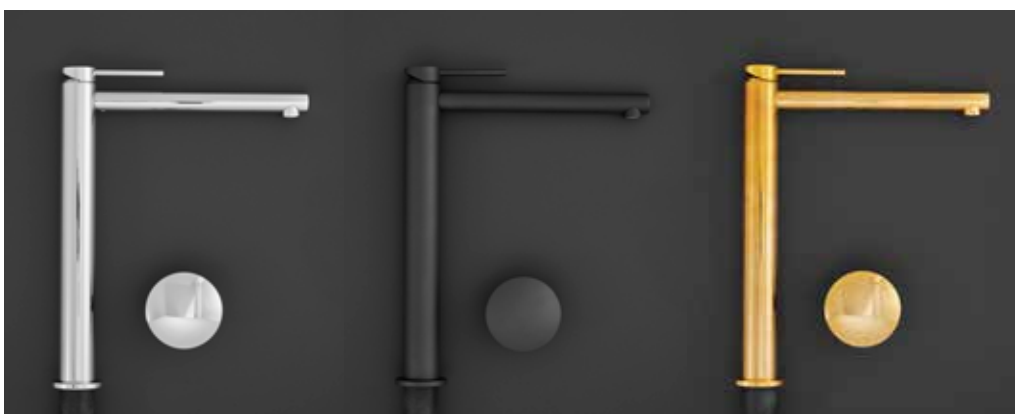
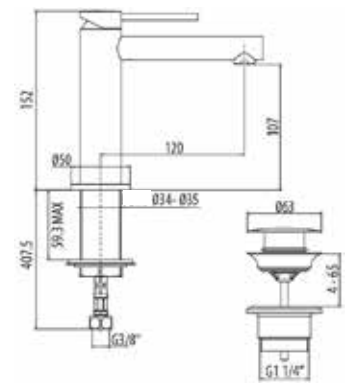

1941C
Chrome
Incl. free flow waste - always open

£495

1941B
Matt Black
Incl. free flow waste - always open

£665

1941MP
Polished untreated Brass
Incl. free flow waste - always open

£495

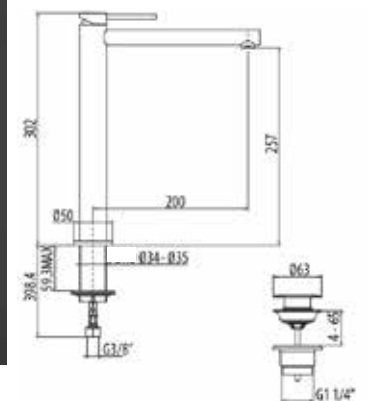

Free Flow waste means it is always open/cannot be closed.
This Free Flow waste is used for sinks that do not have an overflow hole.

Please see more taps on page 130

TAPS AND WASTE



1936C £199
Chrome
 Waste sold separately code 1968C



19370C £295
Chrome
 Delivered with pop up waste

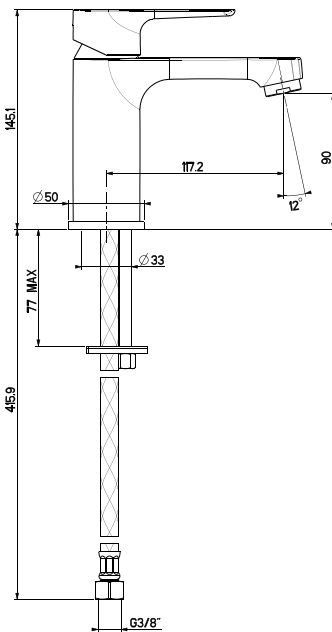
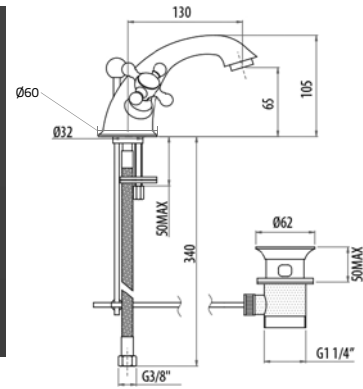

1968C "Pop-up" Waste Chrome £49
 Suits taps 1936C, 1935C

Other mixers are delivered with a waste
 Close/open by pressing the cover cap

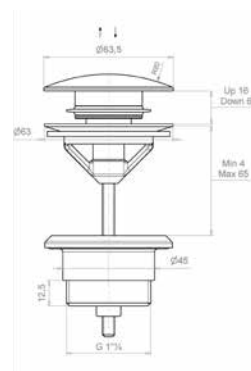

Miller

FINE BATHROOM INTERIORS

ARE YOU LOOKING FOR ASSEMBLY INSTRUCTIONS, MATERIAL FACTS AND CARE ADVICE

Please read more on
millerbathrooms.com/uk/support/material
millerbathrooms.com/uk/support/installation

PRICES ETC

Prices listed in this brochure are approximate prices Sterling pounds including VAT, excluding shipping. Variations may occur. We reserve the right to adjust prices without notice.

GUARANTEE

Please read more on our website www.millerbathrooms.co.uk/guarantee

PHOTOGRAPHY

Richard Lindor, Patrik Svedberg, Nils Åstrand.

PROPS FOR PHOTOGRAPHY

Bovalls Dörrbyggeri, Byarums Bruk, Sonarps Interiör, Växbo Lin, Hide-a-Lite, Kilands Mattor, Karl Andersson och Söner, CC Höganäs, Severins Möbler, Swedese, Sofacompany.com, Numero74 Gardin Olsson och Västanhem.

The colour illustrations and measurements in this catalogue are for guidance only. Every care has been made to ensure that the product information is correct at time of printing. The company reserves the right to make alterations to the described designs, specifications, measurements and prices without prior notice or obligation. E&OE.

All illustrations and materials included in this catalogue are the copyright of Miller from Sweden Ltd. and cannot be used without prior written permission in any other publication, catalogue, brochure, advertisement or in any media what so ever, whether electronic or written including the internet. © 2025 Miller from Sweden Ltd.

HANDLES AND KNOBS

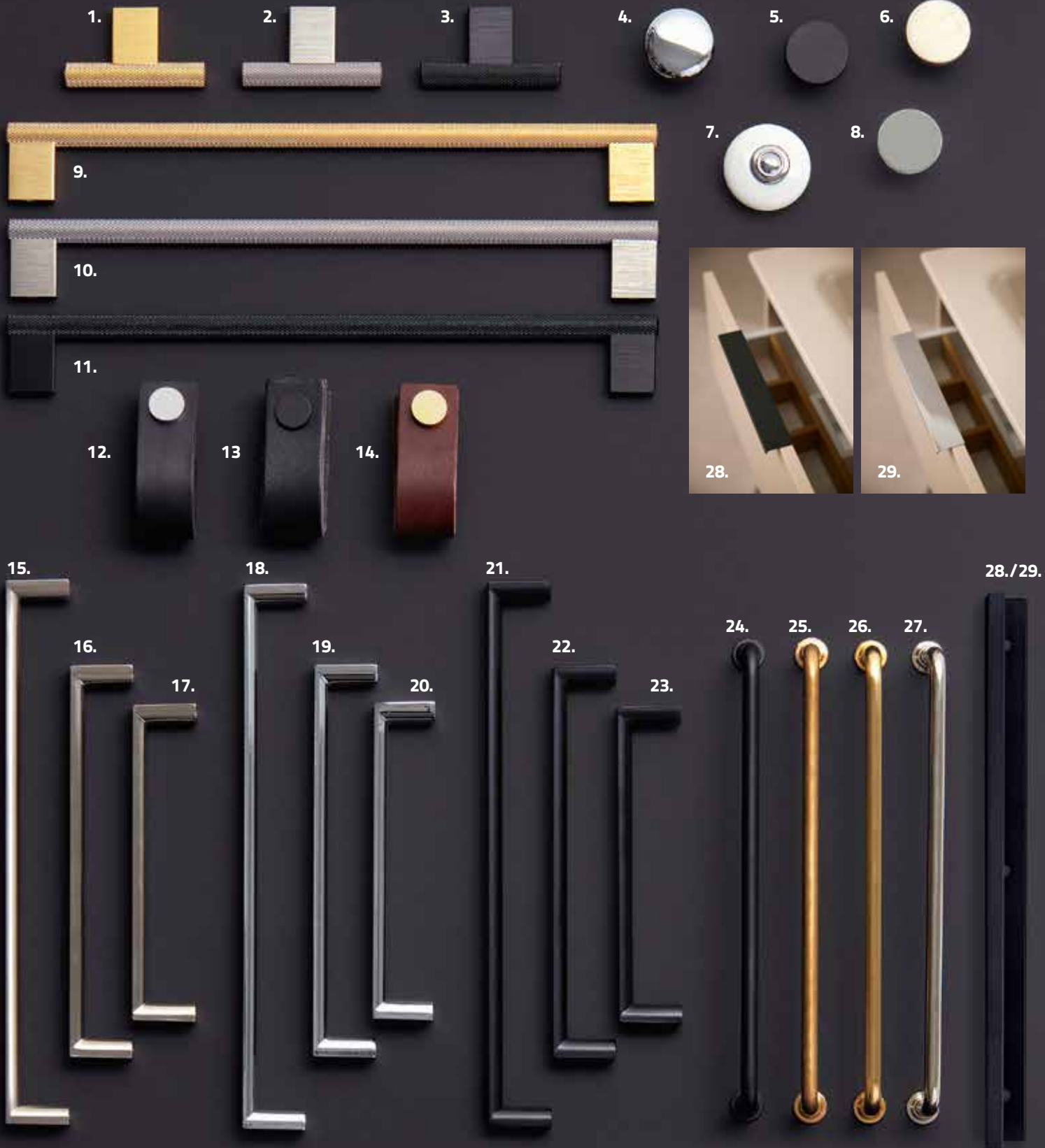

1.	Knob	3102MP	Brass	L60, D10 mm	£14
2.	Knob	3102BN	Brushed Nickel	L60, D10 mm	£14
3.	Knob	3102B	Matt Black	L60, D10 mm	£14
4.	Knob	3103C	Chrome	B30 mm	£10
5.	Knob	3101B	Matt Black	Ø28, D25 mm	£10
6.	Knob	3101BN	Brushed Nickel	Ø28, D25 mm	£10
7.	Knob	3105C	Chrome/white	Ø36 mm	£15
8.	Knob	3101C	Chrome	Ø28, D25 mm	£10
9.	Handle	3002-256MP	Brass	c/c 256 mm	£24
10.	Handle	3002-256BN	Brushed Nickel	c/c 256 mm	£24
11.	Handle	3002-256B	Matt Black	c/c 256 mm	£24
12.	Handle	3104C	Leather Black/Chrome	25x65 mm	£15
13.	Handle	3104B	Leather Black/svart	25x65 mm	£15
14.	Handle	3104MP	Leather Brown/Brass	25x65 mm	£15

15.	Handle	3001-224BN	Brushed Nickel	c/c 224 mm	£14
16.	Handle	3001-160BN	Brushed Nickel	c/c 160 mm	£14
17.	Handle	3001-128BN	Brushed Nickel	c/c 128 mm	£14
18.	Handle	3001-224C	Chrome	c/c 224 mm	£14
19.	Handle	3001-160C	Chrome	c/c 160 mm	£14
20.	Handle	3001-128C	Chrome	c/c 128 mm	£14
21.	Handle	3001-224B	Matt Black	c/c 224 mm	£14
22.	Handle	3001-160B	Matt Black	c/c 160 mm	£14
23.	Handle	3001-128B	Matt Black	c/c 128 mm	£14
24.	Handle	3009-192B	Matt Black	c/c 192 mm	£15
25.	Handle	3009-192MP	Untreated Brass	c/c 192 mm	£15
26.	Handle	3009-192MP1	Brushed Brass	c/c 192 mm	£15
27.	Handle	3009-192C	Chrome	c/c 192 mm	£15
28.	Pull Handle	3006-192B	Matt Black	L 232 mm	£14
29.	Pull Handle	3006-192C	Chrome	L 232 mm	£14

Miller
FINE BATHROOM INTERIORS



MILLER FROM SWEDEN LTD.

Unit 16, Thame Park Business Centre
Wenman Road. Thame OX9 3XA, England
Tel: +44 (0) 1844 264800
sales@millerbathrooms.co.uk

millerbathrooms.co.uk

**Your way.
The Miller Way.**

